

STANDARD CABLES AND ACCESSORIES

HDMI   
ODU HIGH SPEED DATA TECHNOLOGY



CABLE ASSEMBLY

FEATURES

- One point of contact for the complete solution
- Extended cable assembly experience
- High technical expertise regarding our proprietary connectors combined with an excellent technical understanding when it comes to processing third-party products
- Standard and customized overmolding via hot-melt and high-pressure processes in both straight and right-angled designs
- Silicone overmolding for medical products
- 100 % final inspection
- Custom labeling and cable printing
- State-of-the-art manufacturing facilities for small, medium and high volumes at production sites worldwide
- Close collaboration with leading cable manufacturers for the various markets
- Process-controlled solder and crimp monitoring from initial samples to full production
- Cleanroom production possible in accordance with ISO 14644-1:2015
- High-speed data technology system solutions
- Production in accordance with UL possible (File: E333666)

APPLICATIONS

- Medical
- Industrial
- Test and measurement
- Military and security
- Automotive

NOTE

- The catalog is valid worldwide, the following icons (Europe, Asia and USA) indicate the origin of the cables and wires.



- These datasheets are based on actual information. Subject to change. All measurements are approximate and can differ to the delivered goods.
- **Data transmission protocols**
The contact arrangement of an ODU data transmission connector differs from a standard data transmission connector due to the robust ODU specific design. However, the ODU design meets the electrical specifications of the respective standard data transmission protocol.

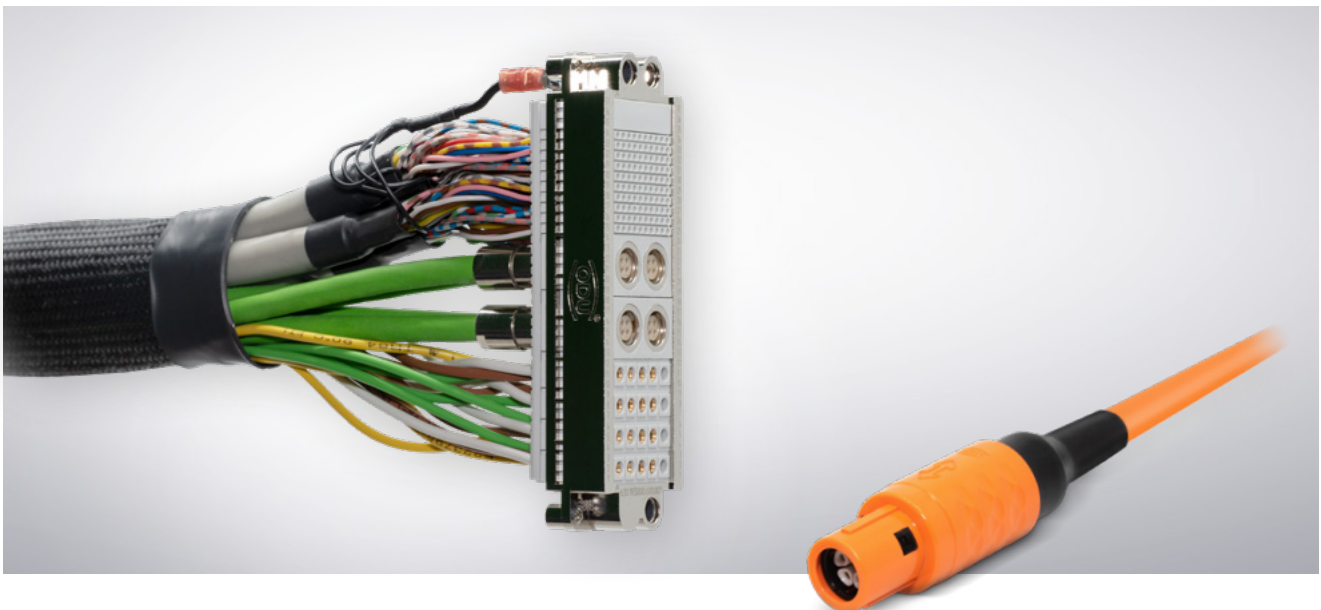

TABLE OF CONTENTS

ODU Express – a brief definition.....	4
Single wires.....	6
Automotive wires FLY / FLRY.....	20
Harmonised wires.....	24
Multi-standard wires.....	28
Multi-Conductor cables.....	32
ODU AMC® preference cables.....	50
Silicone-cables (Gray).....	51
High-Voltage / High-Temperature cables.....	52
Flat ribbon cables.....	54
Coax cables.....	57
Coaxial connectors SMA / BNC.....	58
USB® cables – by the meter.....	59
Data technology cables.....	60
Fiber optic cables.....	72
Cable labeling.....	74
PCB connectors.....	76
Wire terminals.....	79
Corrugated tube glands.....	83
Corrugated tubes / corrugated hoses / braided sleeving.....	84
Cable glands and customizable sealing inserts.....	85
Air and fluid hoses.....	90
Conductor resistances and wire construction.....	91
Basic information cable assembly.....	92
Color code acc. to DIN 47100 / int. color code.....	94

FEATURES

ODU Express is a proven ODU standard product that offers the advantage of fast availability. We therefore recommend to use ODU Express for time-sensitive projects in particular. Our Customer consultants will be happy to advise you on current delivery times.

EXAMPLE

Below is an example of a table and the way it is used on the following pages in this or a similar form.

Part number	Contacts	AWG	Contact type	Connection type	Series	Matching contacts
● 12345678	2	26–28	Socket	Crimp contact	Molex 1.25 mm	87651234
87654321	3	26–28	Socket	Crimp contact	Molex 1.25 mm	32147685
● 12348765	4	26–28	Socket	Crimp contact	Molex 1.25 mm	24135687

①
②
③
④

① Display of availability

② Part number (8 digits)

③ Technical information
(such as: number of cores, dimensions, etc.)

④ If applicable: part number of suitable components
(e.g. sealing inserts)

ODU EXPRESS COLOR CODE

The availability of the article is marked in front of the 8-digit part number. The colored markings indicate the following:

- The green dot marks ODU Express articles. These articles are in stock and thus immediately available – the first choice for time-sensitive projects.



**” SUPPORT FROM START TO
FINISH FROM ONE SOURCE**

Finding the best solution is our challenge.

SINGLE WIRES PVC

UL-Style 1061 / 10002 | UL-Style 1007 / 1569 | UL-Style 1015



TECHNICAL DATA

Conductor	TPC – tin plated copper acc. to EN13602
Insulation	UL-PVC semi rigid (UL-Style 1061 / 10002) UL-PVC 105 °C (UL-Style 1007 / 1569 & 1015)
Temperature range in motion	-10 up to +105°C (UL-Style 10002/1569/1015) -10 up to +80°C (UL-Style 1007) -30 up to +80°C (UL-Style 1061)
Temperature range at rest	-30 up to +105°C (UL-Style 10002/1569/1015) -30 up to +80°C (UL-Style 1007 / 1061)
Test voltage	1,500 V/AC (UL-Style 1061 / 10002) 3,000 V/AC (UL-Style 1007 / 1569) 6,000 V/AC (UL-Style 1015)
Operating voltage	300 V (UL-Style 1061 / 10002 & 1007 / 1569) 600 V (UL-Style 1015)

CROSS SECTION 0.08 mm² / AWG 28 – UL-STYLE 1061 / 10002

Composition: 7 x 0.127 mm

Part number	Color	Wire-Ø in mm
● 50155034	Black	0.90 ± 0.05
● 50155035	Brown	0.90 ± 0.05
● 50155036	Red	0.90 ± 0.05
● 50155037	Orange	0.90 ± 0.05
● 50155038	Yellow	0.90 ± 0.05
● 50155039	Green	0.90 ± 0.05
● 50155040	Blue	0.90 ± 0.05
● 50155041	Violet	0.90 ± 0.05
● 50155042	Gray	0.90 ± 0.05
● 50155043	White	0.90 ± 0.05
50533414	Pink	0.90 ± 0.05
● 50287871	Green-Yellow	0.90 ± 0.05

CROSS SECTION 0.14 mm² / AWG 26 – UL-STYLE 1061 / 10002

Composition: 7 x 0.160 mm

Part number	Color	Wire-Ø in mm
● 50155054	Black	1.00 ± 0.05
● 50155055	Brown	1.00 ± 0.05
● 50155056	Red	1.00 ± 0.05
● 50155057	Orange	1.00 ± 0.05
● 50155058	Yellow	1.00 ± 0.05
● 50155059	Green	1.00 ± 0.05
● 50155060	Blue	1.00 ± 0.05
● 50155061	Violet	1.00 ± 0.05
● 50155062	Gray	1.00 ± 0.05
● 50155063	White	1.00 ± 0.05
50533415	Pink	1.00 ± 0.05
● 50287864	Green-Yellow	1.00 ± 0.05

SINGLE WIRES PVC

UL-Style 1061 / 10002 | UL-Style 1007 / 1569 | UL-Style 1015



CROSS SECTION 0.25 mm² / AWG 24 – UL-STYLE 1061 / 10002

Composition: 7 x 0.203 mm

Part number	Color	Wire-Ø in mm
● 50155281	Black	1.15 ± 0.05
● 50155356	Brown	1.15 ± 0.05
● 50155357	Red	1.15 ± 0.05
● 50155358	Orange	1.15 ± 0.05
● 50155359	Yellow	1.15 ± 0.05
● 50155360	Green	1.15 ± 0.05
● 50155361	Blue	1.15 ± 0.05
● 50155362	Violet	1.15 ± 0.05
● 50155363	Gray	1.15 ± 0.05
● 50155364	White	1.15 ± 0.05
50533423	Pink	1.15 ± 0.05
● 50287861	Green-Yellow	1.15 ± 0.05

CROSS SECTION 0.34 mm² / AWG 22 – UL-STYLE 1061 / 10002

Composition: 7 x 0.254 mm

Part number	Color	Wire-Ø in mm
● 50155074	Black	1.30 ± 0.05
● 50155075	Brown	1.30 ± 0.05
● 50155076	Red	1.30 ± 0.05
● 50155077	Orange	1.30 ± 0.05
● 50155078	Yellow	1.30 ± 0.05
● 50155079	Green	1.30 ± 0.05
● 50155080	Blue	1.30 ± 0.05
● 50155081	Violet	1.30 ± 0.05
● 50155082	Gray	1.30 ± 0.05
● 50155083	White	1.30 ± 0.05
50533426	Pink	1.30 ± 0.05
● 50287856	Green-Yellow	1.30 ± 0.05

CROSS SECTION 0.50 mm² / AWG 20 – UL-STYLE 1061 / 10002

Composition: 7 x 0.320 mm

Part number	Color	Wire-Ø in mm
● 50155094	Black	1.50 ± 0.05
● 50155095	Brown	1.50 ± 0.05
● 50155096	Red	1.50 ± 0.05
● 50155097	Orange	1.50 ± 0.05
● 50155098	Yellow	1.50 ± 0.05
● 50155099	Green	1.50 ± 0.05
● 50155100	Blue	1.50 ± 0.05
● 50155101	Violet	1.50 ± 0.05
● 50155102	Gray	1.50 ± 0.05
● 50155103	White	1.50 ± 0.05
50533427	Pink	1.50 ± 0.05
● 50287851	Green-Yellow	1.50 ± 0.05

CROSS SECTION 1.00 mm² / AWG 18 – UL-STYLE 1007 / 1569

Composition: 28 x 0.2 mm

Part number	Color	Wire-Ø in mm
● 50155114	Black	2.15 ± 0.10
● 50155115	Brown	2.15 ± 0.10
● 50155116	Red	2.15 ± 0.10
● 50155117	Orange	2.15 ± 0.10
● 50155118	Yellow	2.15 ± 0.10
● 50155119	Green	2.15 ± 0.10
● 50155120	Blue	2.15 ± 0.10
● 50155121	Violet	2.15 ± 0.10
● 50155122	Gray	2.15 ± 0.10
● 50155123	White	2.15 ± 0.10
50533428	Pink	2.15 ± 0.10
● 50155180	Green-Yellow	2.15 ± 0.10

SINGLE WIRES PVC

UL-Style 1061 / 10002 | UL-Style 1007 / 1569 | UL-Style 1015



CROSS SECTION 1.5 mm² / AWG 16 – UL-STYLE 1007 / 1569

Composition: 41 x 0.203 mm

Part number	Color	Wire-Ø in mm
● 50155182	Black	2.50 ± 0.10
● 50155183	Brown	2.50 ± 0.10
● 50155184	Red	2.50 ± 0.10
● 50155185	Orange	2.50 ± 0.10
● 50155186	Yellow	2.50 ± 0.10
● 50155187	Green	2.50 ± 0.10
● 50155188	Blue	2.50 ± 0.10
● 50155189	Violet	2.50 ± 0.10
● 50155190	Gray	2.50 ± 0.10
● 50155191	White	2.50 ± 0.10
● 50155202	Green-Yellow	2.50 ± 0.10

CROSS SECTION 2.5 mm² / AWG 14 – UL-STYLE 1569

Composition: 19 x 0.375 mm

Part number	Color	Wire-Ø in mm
● 50155134	Black	2.80 ± 0.10
● 50155135	Brown	2.80 ± 0.10
● 50155136	Red	2.80 ± 0.10
● 50155137	Orange	2.80 ± 0.10
● 50155138	Yellow	2.80 ± 0.10
● 50155139	Green	2.80 ± 0.10
● 50155140	Blue	2.80 ± 0.10
● 50155141	Violet	2.80 ± 0.10
● 50155142	Gray	2.80 ± 0.10
● 50155143	White	2.80 ± 0.10
● 50155181	Green-Yellow	2.80 ± 0.10

CROSS SECTION 4.0 mm² / AWG 12 – UL-STYLE 1015

Composition: 19 x 0.475 mm

Part number	Color	Wire-Ø in mm
● 50289344	Black	4.00 ± 0.10
● 50289345	Brown	4.00 ± 0.10
● 50289346	Red	4.00 ± 0.10
● 50289825	Orange	4.00 ± 0.10
● 50289347	Yellow	4.00 ± 0.10
● 50289348	Green	4.00 ± 0.10
● 50289349	Blue	4.00 ± 0.10
● 50289351	Violet	4.00 ± 0.10
● 50289352	Gray	4.00 ± 0.10
● 50289353	White	4.00 ± 0.10
● 50289354	Green-Yellow	4.00 ± 0.10

CROSS SECTION 6.0 mm² / AWG 10 – UL-STYLE 1015

Composition: 105 x 0.254 mm

Part number	Color	Wire-Ø in mm
● 50289338	Black	5.10 ± 0.10
● 50289339	Brown	5.10 ± 0.10
● 50289340	Blue	5.10 ± 0.10
● 50289341	Gray	5.10 ± 0.10
● 50289342	White	5.10 ± 0.10
● 50289343	Green-Yellow	5.10 ± 0.10

SINGLE WIRES PVC

UL-Style 1061 / 10002 | UL-Style 1007 / 1569 | UL-Style 1015



CROSS SECTION 10.0 mm² / AWG 8 – UL-STYLE 1015

Composition: 72 x 0.39 mm

Part number	Color	Wire-Ø in mm
● 50289334	Black	6.60 ± 0.10
● 50289335	Brown	6.60 ± 0.10
● 50289336	Blue	6.60 ± 0.10
● 50289337	Green-Yellow	6.60 ± 0.10

CROSS SECTION 16.0 mm² / AWG 6 – UL-STYLE 1015

Composition: 266 x 0.25 mm

Part number	Color	Wire-Ø in mm
● 50289330	Black	8.70 ± 0.10
● 50289331	Brown	8.70 ± 0.10
● 50289332	Blue	8.70 ± 0.10
● 50289333	Green-Yellow	8.70 ± 0.10

CROSS SECTION 25.0 mm² / AWG 4 – UL-STYLE 1015

Composition: 196 x 0.40 mm

Part number	Color	Wire-Ø in mm
● 50282013	Black	9.90 ± 0.10
● 50282014	Brown	9.90 ± 0.10
● 50282020	Blue	9.90 ± 0.10
● 50287757	Green-Yellow	9.90 ± 0.10

CROSS SECTION 35.0 mm² / AWG 2 – UL-STYLE 1015

Composition: EN 60228 Kl. 5

Part number	Color	Wire-Ø in mm
● 50287752	Black	10.90 ± 0.30
● 50288182	Brown	10.90 ± 0.30
● 50287755	Blue	10.90 ± 0.30
● 50287756	Green-Yellow	10.90 ± 0.30

CROSS SECTION 50.0 mm² / AWG 1 – UL-STYLE 1015

Composition: EN 60228 Kl. 5

Part number	Color	Wire-Ø in mm
● 50287749	Black	13.50 ± 0.40
● 50288199	Green-Yellow	13.50 ± 0.40

SINGLE WIRES PVC

UL-Style 1007



TECHNICAL DATA

Conductor	TPC – tin plated copper
Insulation	UL-PVC 105 °C (UL-Style 1007)
Temperature range	–40 °C up to +80 °C
Test voltage	3,000 V
Operating voltage	300 V

CROSS SECTION 0.09 mm² / AWG 28

Composition: 7 x 0.13 mm

Part number	Color	Wire-Ø in mm
50518905	Black	1.19
● 50005782	Brown	1.19
50518906	Red	1.19
50518907	Orange	1.19
50518908	Yellow	1.19
50518909	Green	1.19
● 50005781	Blue	1.19
50518910	White	1.19

CROSS SECTION 0.14 mm² / AWG 26

Composition: 7 x 0.16 mm

Part number	Color	Wire-Ø in mm
50518911	Black	1.30
50518912	Brown	1.30
● 50005798	Red	1.30
50518913	Orange	1.30
50518914	Yellow	1.30
50518915	Green	1.30
50518916	Blue	1.30
50518917	White	1.30

CROSS SECTION 0.23 mm² / AWG 24

Composition: 7 x 0.20 mm

Part number	Color	Wire-Ø in mm
● 50005777	Black	1.42
● 50005863	Brown	1.42
● 50005778	Red	1.42
● 50005864	Orange	1.42
● 50005861	Yellow	1.42
● 50005779	Green	1.42
● 50005862	Blue	1.42
● 50005776	White	1.42

CROSS SECTION 0.35 mm² / AWG 22

Composition: 7 x 0.25 mm

Part number	Color	Wire-Ø in mm
● 50005699	Black	1.57
● 50005704	Brown	1.57
● 50005700	Red	1.57
● 50005705	Orange	1.57
● 50005702	Yellow	1.57
● 50005701	Green	1.57
● 50005703	Blue	1.57
● 50005698	White	1.57

SINGLE WIRES PVC

UL-Style 1007 / 1569



TECHNICAL DATA

Conductor	TPC – tin plated copper acc. to EN13602
Insulation	UL-PVC semi rigid (UL-Style 1061 / 10002) UL-PVC (UL-Style 1007 / 1569 & 1015)
Temperature range in motion	-10 up to +105°C (UL-Style 10002/1569/1015) -10 up to +80°C (UL-Style 1007) -30 up to +80°C (UL-Style 1061)
Temperature range at rest	-30 up to +105°C (UL-Style 10002/1569/1015) -30 up to +80°C (UL-Style 1007 / 1061)
Test voltage	1,500 V/AC (UL-Style 1061 / 10002) 3,000 V/AC (UL-Style 1007 / 1569) 6,000 V/AC (UL-Style 1015)
Operating voltage	300 V (UL-Style 1061 / 10002 & 1007 / 1569) 600 V (UL-Style 1015)

CROSS SECTION 0.09 mm² / AWG 28

Composition: 7 x 0.13 mm

Part number	Color	Wire-Ø in mm
50523042	Black	1.19
50523043	Brown	1.19
50523044	Red	1.19
50523045	Orange	1.19
50523046	Yellow	1.19
50523047	Green	1.19
50523048	Blue	1.19
50523049	Violet	1.19
50523050	Gray	1.19
50523051	White	1.19
50523052	Green-Yellow	1.19

CROSS SECTION 0.14 mm² / AWG 26

Composition: 7 x 0.16 mm

Part number	Color	Wire-Ø in mm
50523053	Black	1.30
50523054	Brown	1.30
50523055	Red	1.30
50523056	Orange	1.30
50523057	Yellow	1.30
50523058	Green	1.30
50523059	Blue	1.30
50523060	Violet	1.30
50523061	Gray	1.30
50523062	White	1.30
50523063	Green-Yellow	1.30

SINGLE WIRES PVC

UL-Style 1007 / 1569



CROSS SECTION 0.23 mm² / AWG 24

Composition: 7 x 0.20 mm

Part number	Color	Wire-Ø in mm
50523064	Black	1.42
50523065	Brown	1.42
50523066	Red	1.42
50523067	Orange	1.42
50523068	Yellow	1.42
50523069	Green	1.42
50523070	Blue	1.42
50523071	Violet	1.42
50523072	Gray	1.42
50523073	White	1.42
50523074	Green-Yellow	1.42

CROSS SECTION 0.35 mm² / AWG 22

Composition: 7 x 0.25 mm

Part number	Color	Wire-Ø in mm
50523075	Black	1.57
50523076	Brown	1.57
50523077	Red	1.57
50523078	Orange	1.57
50523079	Yellow	1.57
50523080	Green	1.57
50523081	Blue	1.57
50523082	Violet	1.57
50523083	Gray	1.57
50523084	White	1.57
50523085	Green-Yellow	1.57

CROSS SECTION 0.51 mm² / AWG 20

Composition: 10 x 0.25 mm

Part number	Color	Wire-Ø in mm
50523086	Black	1.75
50523087	Brown	1.75
50523088	Red	1.75
50523089	Orange	1.75
50523090	Yellow	1.75
50523091	Green	1.75
50523092	Blue	1.75
50523093	Violet	1.75
50523094	Gray	1.75
50523095	White	1.75
50523096	Green-Yellow	1.75

CROSS SECTION 0.81 mm² / AWG 18

Composition: 16 x 0.25 mm

Part number	Color	Wire-Ø in mm
50523097	Black	2.01
50523098	Brown	2.01
50523099	Red	2.01
50523100	Orange	2.01
50523101	Yellow	2.01
50523102	Green	2.01
50523103	Blue	2.01
50523104	Violet	2.01
50523105	Gray	2.01
50523106	White	2.01
50523107	Green-Yellow	2.01

SINGLE WIRES PVC

UL-Style 1007 / 1569



CROSS SECTION 1.32 mm² / AWG 16

Composition: 26 x 0.25 mm

Part number	Color	Wire-Ø in mm
50523108	Black	2.34
50523109	Brown	2.34
50523110	Red	2.34
50523111	Orange	2.34
50523112	Yellow	2.34
50523113	Green	2.34
50523114	Blue	2.34
50523115	Violet	2.34
50523116	Gray	2.34
50523117	White	2.34
50523118	Green-Yellow	2.34

CROSS SECTION 2.08 mm² / AWG 14

Composition: 41 x 0.26 mm

Part number	Color	Wire-Ø in mm
50523119	Black	2.69
50523120	Brown	2.69
50523121	Red	2.69
50523122	Orange	2.69
50523123	Yellow	2.69
50523124	Green	2.69
50523125	Blue	2.69
50523126	Violet	2.69
50523127	Gray	2.69
50523128	White	2.69
50523129	Green-Yellow	2.69

CROSS SECTION 3.30 mm² / AWG 12

Composition: 65 x 0.25 mm

Part number	Color	Wire-Ø in mm
50523130	Black	3.18
50523131	Brown	3.18
50523132	Red	3.18
50523133	Orange	3.18
50523134	Yellow	3.18
50523135	Green	3.18
50523136	Blue	3.18
50523137	Violet	3.18
50523138	Gray	3.18
50523139	White	3.18
50523140	Green-Yellow	3.18

CROSS SECTION 5.32 mm² / AWG 10

Composition: 105 x 0.25 mm

Part number	Color	Wire-Ø in mm
50523141	Black	3.81
50523142	Brown	3.81
50523143	Red	3.81
50523144	Orange	3.81
50523145	Yellow	3.81
50523146	Green	3.81
50523147	Blue	3.81
50523148	Violet	3.81
50523149	Gray	3.81
50523150	White	3.81
50523151	Green-Yellow	3.81

SINGLE WIRES PTFE



TECHNICAL DATA

Conductor	SPC – silver plated copper acc. to EN13602
Insulation	PTFE – 5Y
Temperature range in motion	–65 up to +200 °C
Temperature range at rest	–65 up to +200 °C
Test voltage	3,400 V/AC
Operating voltage	600 V

CROSS SECTION 0.08 mm² / AWG 28

Composition: 7 x 0.127 mm

Part number	Color	Wire-Ø in mm
● 50155650	Black	0.89 ± 0.10
● 50155651	Brown	0.89 ± 0.10
● 50155652	Red	0.89 ± 0.10
● 50155653	Orange	0.89 ± 0.10
● 50155654	Yellow	0.89 ± 0.10
● 50155655	Green	0.89 ± 0.10
● 50155656	Blue	0.89 ± 0.10
● 50155657	Violet	0.89 ± 0.10
● 50155658	Gray	0.89 ± 0.10
● 50155659	White	0.89 ± 0.10

CROSS SECTION 0.14 mm² / AWG 26

Composition: 7 x 0.160 mm

Part number	Color	Wire-Ø in mm
● 50243012	Black	0.99 ± 0.10
● 50243006	Brown	0.99 ± 0.10
● 50243011	Red	0.99 ± 0.10
● 50284961	Orange	0.99 ± 0.10
● 50243008	Yellow	0.99 ± 0.10
● 50243007	Green	0.99 ± 0.10
● 50243010	Blue	0.99 ± 0.10
● 50243013	Violet	0.99 ± 0.10
● 50243009	Gray	0.99 ± 0.10
● 50243005	White	0.99 ± 0.10

SINGLE WIRES PTFE



CROSS SECTION 0.25 mm² / AWG 24

Composition: 19 x 0.127 mm

Part number	Color	Wire-Ø in mm
● 50155319	Black	1.13 ± 0.10
● 50154980	Brown	1.13 ± 0.10
● 50154971	Red	1.13 ± 0.10
● 50154972	Orange	1.13 ± 0.10
● 50154976	Yellow	1.13 ± 0.10
● 50154970	Green	1.13 ± 0.10
● 50154975	Blue	1.13 ± 0.10
● 50154968	Violet	1.13 ± 0.10
● 50154979	Gray	1.13 ± 0.10
● 50154981	White	1.13 ± 0.10

CROSS SECTION 0.34 mm² / AWG 22

Composition: 19 x 0.160 mm

Part number	Color	Wire-Ø in mm
● 50154965	Black	1.27 ± 0.10
● 50154967	Brown	1.27 ± 0.10
● 50154964	Red	1.27 ± 0.10
● 50155269	Orange	1.27 ± 0.10
● 50154962	Yellow	1.27 ± 0.10
● 50155325	Green	1.27 ± 0.10
● 50154963	Blue	1.27 ± 0.10
● 50155326	Violet	1.27 ± 0.10
● 50154961	Gray	1.27 ± 0.10
● 50154966	White	1.27 ± 0.10

CROSS SECTION 0.5 mm² / AWG 20

Composition: 19 x 0.203 mm

Part number	Color	Wire-Ø in mm
● 50155280	Black	1.47 ± 0.10
● 50155337	Brown	1.47 ± 0.10
● 50155338	Red	1.47 ± 0.10
● 50155339	Orange	1.47 ± 0.10
● 50155340	Yellow	1.47 ± 0.10
● 50155341	Green	1.47 ± 0.10
● 50155342	Blue	1.47 ± 0.10
● 50155343	Violet	1.47 ± 0.10
● 50155344	Gray	1.47 ± 0.10
● 50155345	White	1.47 ± 0.10

CROSS SECTION 1.0 mm² / AWG 18

Composition: 19 x 0.254 mm

Part number	Color	Wire-Ø in mm
● 50287888	Black	1.75 ± 0.10
● 50287882	Brown	1.75 ± 0.10
● 50287887	Red	1.75 ± 0.10
● 50287890	Orange	1.75 ± 0.10
● 50287884	Yellow	1.75 ± 0.10
● 50287883	Green	1.75 ± 0.10
● 50287886	Blue	1.75 ± 0.10
● 50287889	Violet	1.75 ± 0.10
● 50287885	Gray	1.75 ± 0.10
● 50287881	White	1.75 ± 0.10

SINGLE WIRES PTFE

UL-Style 1213



TECHNICAL DATA

Conductor	SPC – silver plated copper
Insulation	PTFE UL-Style 1213
Temperature range	-60 up to +200 °C
Test voltage	3,000 V/AC
Operating voltage	600 V

CROSS SECTION 0.08 mm² / AWG 28

Composition: 7 x 0.13 mm

Part number	Color	Wire-Ø in mm
50519117	Black	0.91
50518960	Brown	0.91
50519118	Red	0.91
50518961	Orange	0.91
50518962	Yellow	0.91
50518963	Green	0.91
50518964	Blue	0.91
50519122	White	0.91

CROSS SECTION 0.14 mm² / AWG 26

Composition: 7 x 0.16 mm

Part number	Color	Wire-Ø in mm
● 50005745	Black	1.02
50518969	Brown	1.02
● 50005744	Red	1.02
50518970	Orange	1.02
50518971	Yellow	1.02
50518972	Green	1.02
50518973	Blue	1.02
● 50007208	White	1.02

CROSS SECTION 0.25 mm² / AWG 24

Composition: 7 x 0.2 mm

Part number	Color	Wire-Ø in mm
● 50005912	Black	1.12
50519013	Brown	1.12
50519014	Red	1.12
50519015	Orange	1.12
50519016	Yellow	1.12
● 50005910	Green	1.12
● 50005911	Blue	1.12
50519017	White	1.12

CROSS SECTION 0.38 mm² / AWG 22

Composition: 19 x 0.16 mm

Part number	Color	Wire-Ø in mm
● 50291791	Black	1.30
● 50519018	Brown	1.30
● 50291792	Red	1.30
50519019	Orange	1.30
50519020	Yellow	1.30
50519021	Green	1.30
● 50519022	Blue	1.30
● 50005839	White	1.30



ODU-MAC® BLUE-LINE

The flexible modular design of the ODU-MAC® Blue-Line enables the combination of different transmission types within one connector. Whether signal, high-voltage, power, high-current, HF signals (coax), compressed air, fluid, vacuum, data or fiber optic.

SINGLE WIRES PTFE

MIL-M-16878/4 (Type E)



TECHNICAL DATA

Conductor	SPC – silver plated copper
Insulation	Polytetrafluoroethylene (PTFE)
Temperature range	-65 up to +200 °C
Test voltage	3,400 V/AC
Operating voltage	600 V

CROSS SECTION 0.09 mm² / AWG 28

Composition: 7 x 0.13 mm

Part number	Color	Wire-Ø in mm
50522981	Black	0.89
50522982	Brown	0.89
50522983	Red	0.89
50522984	Orange	0.89
50522985	Yellow	0.89
50522986	Green	0.89
50522987	Blue	0.89
50522988	Violet	0.89
50522989	Gray	0.89
50522990	White	0.89

CROSS SECTION 0.14 mm² / AWG 26

Composition: 7 x 0.16 mm

Part number	Color	Wire-Ø in mm
50522991	Black	0.99
50522992	Brown	0.99
50522993	Red	0.99
50522994	Orange	0.99
50522995	Yellow	0.99
50522996	Green	0.99
50522997	Blue	0.99
50522998	Violet	0.99
50522999	Gray	0.99
50523000	White	0.99

SINGLE WIRES PTFE

MIL-M-16878/4 (Type E)



CROSS SECTION 0.24 mm² / AWG 24

Composition: 19 x 0.13 mm

Part number	Color	Wire-Ø in mm
50523001	Black	1.12
50523002	Brown	1.12
50523003	Red	1.12
50523004	Orange	1.12
50523005	Yellow	1.12
50523006	Green	1.12
50523007	Blue	1.12
50523008	Violet	1.12
50523009	Gray	1.12
50523010	White	1.12

CROSS SECTION 0.38 mm² / AWG 22

Composition: 19 x 0.16 mm

Part number	Color	Wire-Ø in mm
50523011	Black	1.27
50523012	Brown	1.27
50523013	Red	1.27
50523014	Orange	1.27
50523015	Yellow	1.27
50523016	Green	1.27
50523017	Blue	1.27
50523018	Violet	1.27
50523019	Gray	1.27
50523020	White	1.27

CROSS SECTION 0.62 mm² / AWG 20

Composition: 19 x 0.20 mm

Part number	Color	Wire-Ø in mm
50523021	Black	1.47
50523022	Brown	1.47
50523023	Red	1.47
50523024	Orange	1.47
50523025	Yellow	1.47
50523026	Green	1.47
50523027	Blue	1.47
50523028	Violet	1.47
50523029	Gray	1.47
50523030	White	1.47

CROSS SECTION 0.96 mm² / AWG 18

Composition: 19 x 0.25 mm

Part number	Color	Wire-Ø in mm
50523031	Black	1.75
50523032	Brown	1.75
50523033	Red	1.75
50523034	Orange	1.75
50523035	Yellow	1.75
50523036	Green	1.75
50523037	Blue	1.75
50523038	Violet	1.75
50523039	Gray	1.75
50523040	White	1.75

AUTOMOTIVE WIRES

FLY / FLRY acc. to ISO 6722



TECHNICAL DATA

Conductor	Bare copper acc. to EN13602
Insulation	PVC acc. to ISO 6722 Class A (FLY) PVC acc. to ISO 6722 Class B (FLRY)
Temperature range in motion	-40 up to +85 °C (FLY) -40 up to +105 °C (FLRY)
Temperature range at rest	-25 up to +85 °C (FLY) -40 up to +105 °C (FLRY)
Test voltage	1,000 V/AC
Operating voltage	60 V

CROSS SECTION 0.35 mm² / PVC ACC. TO ISO 6722 CLASS B (FLRY)

Composition: 7 x 0.25 mm – Typ A

Part number	Color	Max. wire-Ø in mm
● 50243457	Black	1.30
● 50243459	Brown	1.30
● 50243458	Red	1.30
● 50288155	Orange	1.30
● 50288150	Yellow	1.30
● 50288149	Green	1.30
● 50288153	Blue	1.30
● 50288154	Violet	1.30
● 50288151	Gray	1.30
● 50247115	White	1.30
● 50288152	Pink	1.30

CROSS SECTION 0.50 mm² / PVC ACC. TO ISO 6722 CLASS B (FLRY)

Composition: 19 x 0.19 mm – Typ A

Part number	Color	Max. wire-Ø in mm
● 50155721	Black	1.60
● 50243475	Brown	1.60
● 50155722	Red	1.60
● 50253018	Orange	1.60
● 50252321	Yellow	1.60
● 50252320	Green	1.60
● 50155261	Blue	1.60
● 50288148	Violet	1.60
● 50288147	Gray	1.60
● 50155260	White	1.60
● 50274458	Pink	1.60

AUTOMOTIVE WIRES

FLY / FLRY acc. to ISO 6722



CROSS SECTION 0.75 mm² / PVC ACC. TO ISO 6722 CLASS B (FLRY)

Composition: 24 x 0.20 mm – Typ B

Part number	Color	Max. wire-Ø in mm
● 50243479	Black	1.90
● 50243482	Brown	1.90
● 50155703	Red	1.90
● 50288116	Orange	1.90
● 50288111	Yellow	1.90
● 50288110	Green	1.90
● 50288114	Blue	1.90
● 50288115	Violet	1.90
● 50288112	Gray	1.90
● 50288109	White	1.90
● 50288113	Pink	1.90

CROSS SECTION 1.00 mm² / PVC ACC. TO ISO 6722 CLASS B (FLRY)

Composition: 32 x 0.20 mm – Typ B

Part number	Color	Max. wire-Ø in mm
● 50243535	Black	2.10
● 50155252	Brown	2.10
● 50155254	Red	2.10
● 50288086	Orange	2.10
● 50288081	Yellow	2.10
● 50288080	Green	2.10
● 50288084	Blue	2.10
● 50288085	Violet	2.10
● 50288082	Gray	2.10
● 50248600	White	2.10
● 50288083	Pink	2.10

CROSS SECTION 1.50 mm² / PVC ACC. TO ISO 6722 CLASS B (FLRY)

Composition: 30 x 0.25 mm – Typ B

Part number	Color	Max. wire-Ø in mm
● 50243537	Black	2.40
● 50243540	Brown	2.40
● 50243539	Red	2.40
● 50288070	Orange	2.40
● 50288065	Yellow	2.40
● 50288064	Green	2.40
● 50288068	Blue	2.40
● 50288069	Violet	2.40
● 50288066	Gray	2.40
● 50288063	White	2.40
● 50288067	Pink	2.40

CROSS SECTION 2.50 mm² / PVC ACC. TO ISO 6722 CLASS B (FLRY)

Composition: 50 x 0.25 mm – Typ B

Part number	Color	Max. wire-Ø in mm
● 50243544	Black	3.00
● 50243546	Brown	3.00
● 50243545	Red	3.00
● 50288009	Orange	3.00
● 50288005	Yellow	3.00
● 50288004	Green	3.00
● 50288007	Blue	3.00
● 50288008	Violet	3.00
● 50288006	Gray	3.00
● 50247116	White	3.00

AUTOMOTIVE WIRES

FLY / FLRY acc. to ISO 6722



CROSS SECTION 4.00 mm² / PVC ACC. TO ISO 6722 CLASS B (FLRY)

Composition: 56 x 0.30 mm – Typ B

Part number	Color	Max. wire-Ø in mm
● 50243547	Black	3.70
● 50243553	Brown	3.70
● 50243552	Red	3.70
● 50287993	Yellow	3.70
● 50287992	Green	3.70
● 50287995	Blue	3.70
● 50287994	Gray	3.70
● 50287986	White	3.70

CROSS SECTION 6.00 mm² / PVC ACC. TO ISO 6722 CLASS B (FLRY)

Composition: 84 x 0.30 mm – Typ B

Part number	Color	Max. wire-Ø in mm
● 50243555	Black	4.30
● 50243557	Brown	4.30
● 50243556	Red	4.30
● 50274407	Blue	4.30
● 50287982	White	4.30

CROSS SECTION 10.00 mm² / PVC ACC. TO ISO 6722 CLASS A (FLY)

Composition: 80 x 0.40 mm

Part number	Color	Max. wire-Ø in mm
● 50287969	Black	6.00
● 50287963	Brown	6.50
● 50287965	Red	6.50

CROSS SECTION 16.00 mm² / PVC ACC. TO ISO 6722 CLASS A (FLY)

Composition: 128 x 0.40 mm

Part number	Color	Max. wire-Ø in mm
● 50287961	Black	8.30
● 50287958	Brown	8.30
● 50287960	Red	8.30

CROSS SECTION 25.00 mm² / PVC ACC. TO ISO 6722 CLASS A (FLY)

Composition: 196 x 0.40 mm

Part number	Color	Max. wire-Ø in mm
● 50287956	Black	10.40
● 50287955	Brown	10.40
● 50287957	Red	10.40

CROSS SECTION 35.00 mm² / PVC ACC. TO ISO 6722 CLASS A (FLY)

Composition: 276 x 0.40 mm

Part number	Color	Max. wire-Ø in mm
● 50287953	Black	11.60
● 50287947	Red	10.80

CROSS SECTION 50.00 mm² / PVC ACC. TO ISO 6722 CLASS B (FLY)

Composition: 396 x 0.40 mm

Part number	Color	Max. wire-Ø in mm
● 50287946	Black	13.50

ODU-MAC® SILVER- / WHITE-LINE

ODU-MAC® Silver- / White-Line can be configured with up to 600 contacts when the 10 contact module shown below with a module width of 2.54 mm is used.

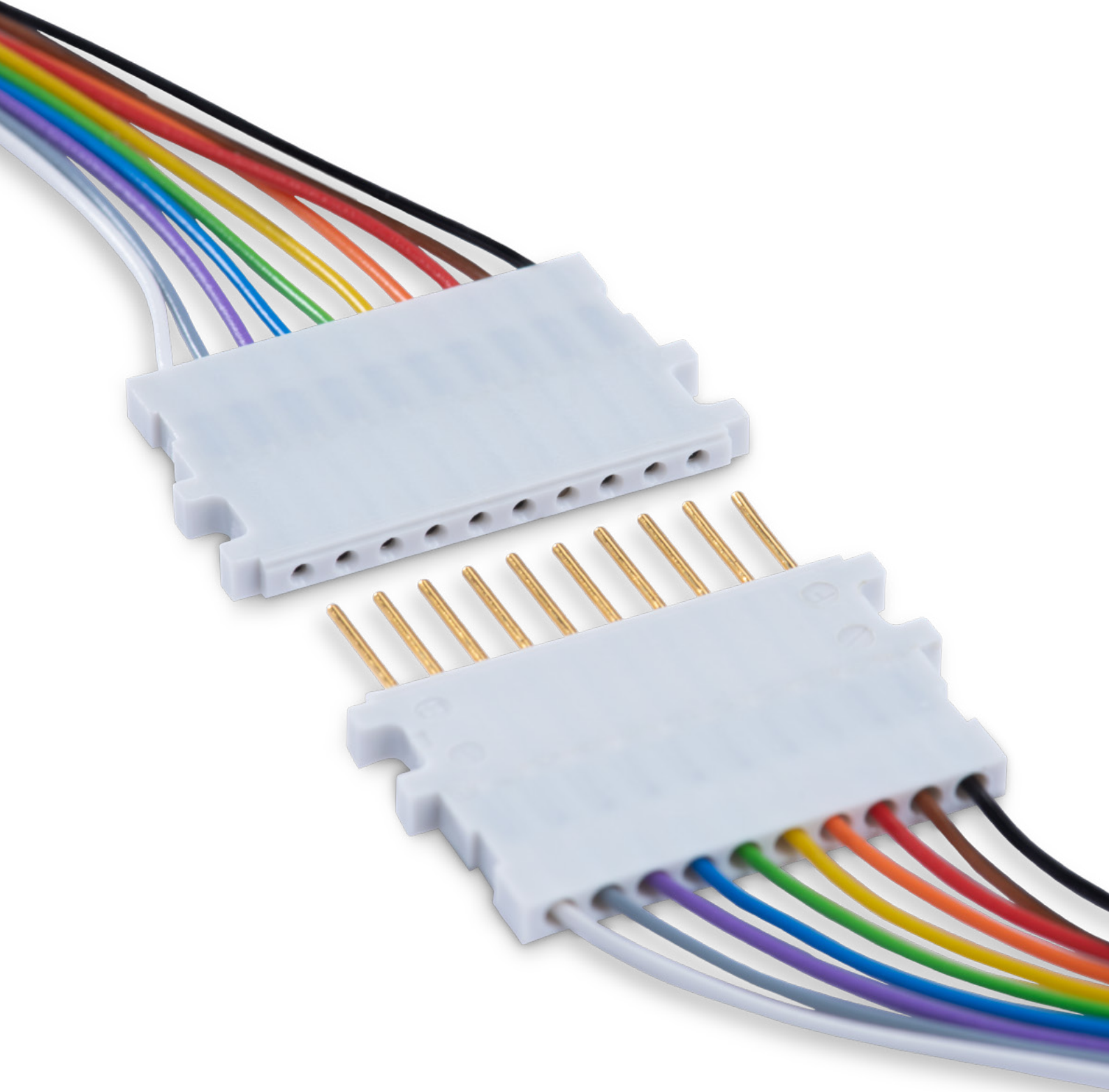

HARMONISED WIRES

H05V-K / H07V-K



TECHNICAL DATA

Conductor	Bare copper acc. to EN13602
Insulation	PVC acc. to VDE 0207 / EN 50363-3
Temperature range in motion	-5 up to +70 °C
Temperature range at rest	-30 up to +70 °C
Test voltage	2,000 V/AC (H05V-K) 2,500 V/AC (H07V-K)
Operating voltage U ₀ / u	300 / 500 V (H05V-K) 450 / 750 V (H07V-K)

CROSS SECTION 0.50 mm² / H05V-K ACC. TO EN 50525-2-31

Composition: 16 x 0.20 mm

Part number	Color	Wire-Ø in mm
● 50154784	Black	2.30 ± 0.20
● 50155377	Brown	2.30 ± 0.20
● 50155378	Red	2.30 ± 0.20
● 50155379	Orange	2.30 ± 0.20
● 50155380	Yellow	2.30 ± 0.20
● 50155381	Green	2.30 ± 0.20
● 50155382	Blue	2.30 ± 0.20
● 50155383	Violet	2.30 ± 0.20
● 50155384	Gray	2.30 ± 0.20
● 50155385	White	2.30 ± 0.20
● 50155386	Green-Yellow	2.30 ± 0.20

CROSS SECTION 0.75 mm² / H05V-K ACC. TO EN 50525-2-31

Composition: 24 x 0.20 mm

Part number	Color	Wire-Ø in mm
● 50154798	Black	2.45 ± 0.25
● 50155387	Brown	2.45 ± 0.25
● 50154997	Red	2.45 ± 0.25
● 50155388	Orange	2.45 ± 0.25
● 50155389	Yellow	2.45 ± 0.25
● 50155390	Green	2.45 ± 0.25
● 50155391	Blue	2.45 ± 0.25
● 50155392	Violet	2.45 ± 0.25
● 50155393	Gray	2.45 ± 0.25
● 50155394	White	2.45 ± 0.25
● 50155395	Green-Yellow	2.45 ± 0.25

HARMONISED WIRES

H05V-K / H07V-K



CROSS SECTION 1.00 mm² / H05V-K ACC. TO EN 50525-2-31

Composition: 32 x 0.20 mm

Part number	Color	Wire-Ø in mm
● 50154768	Black	2.60 ± 0.20
● 50155396	Brown	2.60 ± 0.20
● 50154881	Red	2.60 ± 0.20
● 50155397	Orange	2.60 ± 0.20
● 50155398	Yellow	2.60 ± 0.20
● 50155399	Green	2.60 ± 0.20
● 50154771	Blue	2.60 ± 0.20
● 50154797	Violet	2.60 ± 0.20
● 50154773	Gray	2.60 ± 0.20
● 50154769	White	2.60 ± 0.20
● 50154767	Green-Yellow	2.60 ± 0.20

CROSS SECTION 1.50 mm² / H07V-K ACC. TO EN 50525-2-31

Composition: 30 x 0.25 mm

Part number	Color	Wire-Ø in mm
● 50154787	Black	3.10 ± 0.30
● 50155400	Brown	3.10 ± 0.30
● 50154794	Red	3.10 ± 0.30
● 50155401	Orange	3.10 ± 0.30
● 50155402	Yellow	3.10 ± 0.30
● 50154836	Green	3.10 ± 0.30
● 50154772	Blue	3.10 ± 0.30
● 50155403	Violet	3.10 ± 0.30
● 50154795	Gray	3.10 ± 0.30
● 50154770	White	3.10 ± 0.30
● 50154689	Green-Yellow	3.10 ± 0.30

CROSS SECTION 2.50 mm² / H07V-K ACC. TO EN 50525-2-31

Composition: 50 x 0.25 mm

Part number	Color	Wire-Ø in mm
● 50154746	Black	3.75 ± 0.35
● 50154837	Brown	3.75 ± 0.35
● 50154838	Red	3.75 ± 0.35
● 50155405	Orange	3.75 ± 0.35
● 50155406	Yellow	3.75 ± 0.35
● 50155407	Green	3.75 ± 0.35
● 50155408	Blue	3.75 ± 0.35
● 50155409	Violet	3.75 ± 0.35
● 50155410	Gray	3.75 ± 0.35
● 50155411	White	3.75 ± 0.35
● 50154793	Green-Yellow	3.75 ± 0.35

HARMONISED WIRES

H05V-K / H07V-K



CROSS SECTION 4.00 mm² / H07V-K ACC. TO EN 50525-2-31

Composition: 56 x 0.30 mm

Part number	Color	Wire-Ø in mm
● 50154839	Black	4.35 ± 0.45
● 50155412	Brown	4.35 ± 0.45
● 50155413	Red	4.35 ± 0.45
● 50155414	Orange	4.35 ± 0.45
● 50155415	Yellow	4.35 ± 0.45
● 50155416	Green	4.35 ± 0.45
● 50155417	Blue	4.35 ± 0.45
● 50155418	Violet	4.35 ± 0.45
● 50155419	Gray	4.35 ± 0.45
● 50155420	White	4.35 ± 0.45
● 50154688	Green-Yellow	4.35 ± 0.45

CROSS SECTION 6.00 mm² / H07V-K ACC. TO EN 50525-2-31

Composition: 84 x 0.30 mm

Part number	Color	Wire-Ø in mm
● 50155421	Black	4.85 ± 0.45
● 50154840	Brown	4.85 ± 0.45
● 50154792	Blue	4.85 ± 0.45
● 50154747	Green-Yellow	4.85 ± 0.45

CROSS SECTION 10.00 mm² / H07V-K ACC. TO EN 50525-2-31

Composition: EN 60228; Kl. 5

Part number	Color	Wire-Ø in mm
● 50154788	Black	6.25 ± 0.55
● 50154791	Brown	6.25 ± 0.55
● 50154790	Blue	6.25 ± 0.55
● 50154789	Green-Yellow	6.25 ± 0.55

CROSS SECTION 16.00 mm² / H07V-K ACC. TO EN 50525-2-31

Composition: EN 60228; Kl. 5

Part number	Color	Wire-Ø in mm
● 50282086	Black	7.40 ± 0.70
● 50282087	Brown	7.40 ± 0.70
● 50282092	Blue	7.40 ± 0.70
● 50282096	Green-Yellow	7.40 ± 0.70

CROSS SECTION 25.00 mm² / H07V-K ACC. TO EN 50525-2-31

Composition: EN 60228; Kl. 5

Part number	Color	Wire-Ø in mm
● 50154905	Black	9.30 ± 0.90
● 50282060	Brown	9.30 ± 0.90
● 50282065	Blue	9.30 ± 0.90
● 50282069	Green-Yellow	9.30 ± 0.90

CROSS SECTION 35.00 mm² / H07V-K ACC. TO EN 50525-2-31

Composition: EN 60228; Kl. 5

Part number	Color	Wire-Ø in mm
● 50282038	Black	10.70 ± 1.00
● 50282043	Brown	10.70 ± 1.00
● 50282048	Blue	10.70 ± 1.00
● 50282052	Green-Yellow	10.70 ± 1.00



ODU-MAC® BLUE-LINE

The compact, sealed ODU-MAC® PUSH-LOCK housing with push-pull locking can be custom-fitted with different connector configurations offering International Protection class IP67.

MULTI-STANDARD WIRES

Xtra Basic Style 1015 UL / CSA / HAR H05 / 07V2-K / MTW



TECHNICAL DATA

Conductor	TPC – tin plated copper acc. to EN13602
Insulation	UL-PVC 105 °C
Temperature range in motion	–10 up to +105 °C (VDE, MTW +90 °C)
Temperature range at rest	–40 up to +105 °C (VDE, MTW +90 °C)
Test voltage	3,000 V/AC
Operating voltage UL	600 V
	300 / 500 V (H05xx-K: U ₀ / U)
	450 / 750 V (H07xx-K: U ₀ / U)

CROSS SECTION 0.50 mm²

Composition: EN 60228; Kl.5 – AWG21

Part number	Color	Wire-Ø in mm
● 50245176	Black	2.50 ± 0.10
● 50288221	Brown	2.50 ± 0.10
● 50288226	Red	2.50 ± 0.10
● 50288228	Orange	2.50 ± 0.10
● 50288223	Yellow	2.50 ± 0.10
● 50288222	Green	2.50 ± 0.10
● 50288225	Blue	2.50 ± 0.10
● 50288227	Violet	2.50 ± 0.10
● 50288224	Gray	2.50 ± 0.10
● 50288220	White	2.50 ± 0.10
● 50288229	Dark Blue	2.50 ± 0.10
● 50288230	Green-Yellow	2.50 ± 0.10

CROSS SECTION 0.75 mm²

Composition: EN 60228; Kl.5 – AWG19

Part number	Color	Wire-Ø in mm
● 50245178	Black	2.70 ± 0.10
● 50288212	Brown	2.70 ± 0.10
● 50288217	Red	2.70 ± 0.10
● 50288218	Orange	2.70 ± 0.10
● 50288214	Yellow	2.70 ± 0.10
● 50288213	Green	2.70 ± 0.10
● 50288216	Blue	2.70 ± 0.10
● 50288215	Gray	2.70 ± 0.10
● 50288211	White	2.70 ± 0.10
● 50288219	Green-Yellow	2.70 ± 0.10

MULTI-STANDARD WIRES

Xtra Basic Style 1015 UL / CSA / HAR H05 / 07V2-K / MTW



CROSS SECTION 1.00 mm²

Composition: EN 60228; Kl.5 – AWG18

Part number	Color	Wire-Ø in mm
● 50155709	Black	2.80 ± 0.10
● 50155710	Brown	2.80 ± 0.10
● 50155711	Red	2.80 ± 0.10
● 50155712	Orange	2.80 ± 0.10
● 50288208	Yellow	2.80 ± 0.10
● 50288207	Green	2.80 ± 0.10
● 50155713	Blue	2.80 ± 0.10
● 50288209	Gray	2.80 ± 0.10
● 50288206	White	2.80 ± 0.10
● 50288210	Green-Yellow	2.80 ± 0.10

CROSS SECTION 1.50 mm²

Composition: EN 60228; Kl.5 – AWG16

Part number	Color	Wire-Ø in mm
● 50245201	Black	3.10 ± 0.25
● 50288193	Brown	3.10 ± 0.25
● 50243668	Red	3.10 ± 0.25
● 50243731	Orange	3.10 ± 0.25
● 50243729	Yellow	3.10 ± 0.25
● 50243730	Green	3.10 ± 0.25
● 50288195	Blue	3.10 ± 0.25
● 50288196	Violet	3.10 ± 0.25
● 50288194	Gray	3.10 ± 0.25
● 50288192	White	3.10 ± 0.25
● 50288198	Green-Yellow	3.10 ± 0.25
● 50288197	Dark Blue	3.10 ± 0.25

CROSS SECTION 2.50 mm²

Composition: EN 60228; Kl.5 – AWG14

Part number	Color	Wire-Ø in mm
● 50155714	Black	3.65 ± 0.25
● 50155715	Brown	3.65 ± 0.25
● 50155716	Red	3.65 ± 0.25
● 50288189	Yellow	3.65 ± 0.25
● 50288188	Green	3.65 ± 0.25
● 50155717	Blue	3.65 ± 0.25
● 50288190	Gray	3.65 ± 0.25
● 50288187	White	3.65 ± 0.25
● 50155718	Green-Yellow	3.65 ± 0.25

CROSS SECTION 4.00 mm²

Composition: EN 60228; Kl.5 – AWG12

Part number	Color	Wire-Ø in mm
● 50155227	Black	4.30 ± 0.25
● 50288173	Brown	4.30 ± 0.25
● 50288178	Red	4.30 ± 0.25
● 50288175	Yellow	4.30 ± 0.25
● 50288174	Green	4.30 ± 0.25
● 50288177	Blue	4.30 ± 0.25
● 50288176	Gray	4.30 ± 0.25
● 50288172	White	4.30 ± 0.25
● 50288180	Green-Yellow	4.30 ± 0.25
● 50288179	Dark Blue	4.30 ± 0.25

MULTI-STANDARD WIRES

Xtra Basic Style 1015 UL / CSA / HAR H05 / 07V2-K / MTW



CROSS SECTION 6.00 mm²

Composition: EN 60228; Kl.5 – AWG10

Part number	Color	Wire-Ø in mm
● 50245202	Black	4.82 ± 0.25
● 50288054	Brown	4.82 ± 0.25
● 50288059	Red	4.82 ± 0.25
● 50288060	Orange	4.82 ± 0.25
● 50288056	Yellow	4.82 ± 0.25
● 50288055	Green	4.82 ± 0.25
● 50288058	Blue	4.82 ± 0.25
● 50288057	Gray	4.82 ± 0.25
● 50288053	White	4.82 ± 0.25
● 50288062	Green-Yellow	4.82 ± 0.25
● 50288061	Dark Blue	4.82 ± 0.25

CROSS SECTION 10.00 mm²

Composition: EN 60228; Kl.5 – AWG8

Part number	Color	Wire-Ø in mm
● 50288040	Black	6.50 ± 0.25
● 50288045	Brown	6.50 ± 0.25
● 50288052	Red	6.50 ± 0.25
● 50288049	Orange	6.50 ± 0.25
● 50288050	Yellow	6.50 ± 0.25
● 50288044	Green	6.50 ± 0.25
● 50288047	Blue	6.50 ± 0.25
● 50288046	Gray	6.50 ± 0.25
● 50288051	White	6.50 ± 0.25
● 50288043	Green-Yellow	6.50 ± 0.25
● 50288048	Dark Blue	6.50 ± 0.25

CROSS SECTION 16.00 mm²

Composition: EN 60228; Kl.5 – AWG6

Part number	Color	Wire-Ø in mm
● 50155706	Black	8.80 ± 0.25
● 50245136	Brown	8.80 ± 0.25
● 50244805	Red	8.80 ± 0.25
● 50245139	Orange	8.80 ± 0.25
● 50288001	Yellow	8.80 ± 0.25
● 50287996	Green	8.80 ± 0.25
● 50155707	Blue	8.80 ± 0.25
● 50287998	Gray	8.80 ± 0.25
● 50288002	White	8.80 ± 0.25
● 50155708	Green-Yellow	8.80 ± 0.25
● 50287999	Dark Blue	8.80 ± 0.25

CROSS SECTION 25.00 mm²

Composition: EN 60228; Kl.5 – AWG4

Part number	Color	Wire-Ø in mm
● 50155263	Black	9.80 ± 0.40
● 50287964	Brown	9.80 ± 0.40
● 50287987	Red	9.80 ± 0.40
● 50287980	Orange	9.80 ± 0.40
● 50287988	Yellow	9.80 ± 0.40
● 50287962	Green	9.80 ± 0.40
● 50287979	Blue	9.80 ± 0.40
● 50287978	Gray	9.80 ± 0.40
● 50287989	White	9.80 ± 0.40
● 50287959	Green-Yellow	9.80 ± 0.40

MULTI-STANDARD WIRES

Xtra Basic Style 1015 UL / CSA / HAR H05 / 07V2-K / MTW



CROSS SECTION 35.00 mm²

Composition: EN 60228; Kl.5 – AWG2

Part number	Color	Wire-Ø in mm
● 50287752	Black	10.90 ± 0.40
● 50287951	Red	10.90 ± 0.40
● 50287948	Green	10.90 ± 0.40
● 50287755	Blue	10.90 ± 0.40
● 50287952	Gray	10.90 ± 0.40
● 50287950	White	10.90 ± 0.40
● 50287756	Green-Yellow	10.90 ± 0.40

CROSS SECTION 50.00 mm²

Composition: EN 60228; Kl.5 – AWG1

Part number	Color	Wire-Ø in mm
● 50287749	Black	13.50 ± 0.40
● 50287944	Green	13.50 ± 0.40
● 50287945	Blue	13.50 ± 0.40
● 50288199	Green-Yellow	13.50 ± 0.40

MULTI-CONDUCTOR CABLES PVC

Unshielded UL / cUL – LIYY Style 2464 / 2517-10002



TECHNICAL DATA

Conductor	TPC – tin plated copper acc. to EN13602
Insulation	UL-PVC semi rigid
Jacket / Color	PVC / Black
Temperature range in motion	-10 up to +80 °C (style 2464) -10 up to +105 °C (style 2517)
Temperature range at rest	-30 up to +80 °C (style 2464) -30 up to +105 °C (style 2517)
Test voltage	1,500 V/AC
Operating voltage UL	300 V
Wire colors	acc. to IC-Code

CROSS SECTION 0.08 mm² – AWG 28

Composition: 7 x 0.127 mm

Part number	No. of cores	Dimensions in mm	
		Outer-Ø	Core-Ø
● 50154142	4	3.90 ± 0.20	0.90 ± 0.10
50287863	5	4.55 ± 0.20	0.90 ± 0.10
● 50153903	6	4.40 ± 0.20	0.90 ± 0.10
50287803	8	4.60 ± 0.20	0.90 ± 0.10
50287866	9	5.40 ± 0.20	0.90 ± 0.10
● 50287804	10	5.30 ± 0.20	0.90 ± 0.10
50287806	12	5.60 ± 0.20	0.90 ± 0.10
50287807	14	5.80 ± 0.20	0.90 ± 0.10
50287829	20	6.50 ± 0.20	0.90 ± 0.10
50290825	26	7.40 ± 0.25	0.90 ± 0.10

CROSS SECTION 0.14 mm² – AWG 26

Composition: 7 x 0.160 mm

Part number	No. of cores	Dimensions in mm	
		Outer-Ø	Core-Ø
● 50154098	2	3.70 ± 0.20	1.00 ± 0.10
● 50245269	3	3.80 ± 0.20	1.00 ± 0.10
● 50153862	4	4.10 ± 0.20	1.00 ± 0.10
● 50153864	6	4.70 ± 0.20	1.00 ± 0.10
50287853	7	4.80 ± 0.20	1.00 ± 0.10
● 50153866	8	5.10 ± 0.20	1.00 ± 0.10
● 50245270	10	5.70 ± 0.20	1.00 ± 0.10
● 50287795	12	5.90 ± 0.20	1.00 ± 0.10
50287797	14	6.20 ± 0.20	1.00 ± 0.10
● 50153869	16	6.50 ± 0.20	1.00 ± 0.10
● 50287854	19	7.10 ± 0.25	1.00 ± 0.10
● 50287857	20	7.10 ± 0.25	1.00 ± 0.10
50287862	22	7.50 ± 0.25	1.00 ± 0.10

MULTI-CONDUCTOR CABLES PVC

Unshielded UL / cUL – LIYY Style 2464 / 2517-10002



CROSS SECTION 0.34 mm² – AWG 22

Composition: 7 x 0.254 mm

Part number	No. of cores	Dimensions in mm	
		Outer-Ø	Core-Ø
● 50153877	2	4.30 ± 0.20	1.30 ± 0.05
● 50153878	3	4.50 ± 0.20	1.30 ± 0.05
● 50153879	4	4.80 ± 0.20	1.30 ± 0.05
50287831	5	5.30 ± 0.20	1.30 ± 0.05
● 50153881	6	5.70 ± 0.20	1.30 ± 0.05
● 50153883	8	6.20 ± 0.20	1.30 ± 0.05
● 50153884	10	6.90 ± 0.20	1.30 ± 0.05
● 50287792	12	7.20 ± 0.20	1.30 ± 0.05
50287793	14	7.60 ± 0.20	1.30 ± 0.05

CROSS SECTION 0.50 mm² – AWG 20

Composition: 7 x 0.320 mm

Part number	No. of cores	Dimensions in mm	
		Outer-Ø	Core-Ø
● 50153895	2	4.70 ± 0.20	1.50 ± 0.10
● 50153896	3	4.90 ± 0.20	1.50 ± 0.10
● 50153897	4	5.40 ± 0.20	1.50 ± 0.10
50287830	5	5.80 ± 0.20	1.50 ± 0.10
● 50153899	6	6.30 ± 0.20	1.50 ± 0.10
50287842	7	6.40 ± 0.20	1.50 ± 0.10
50287784	8	6.80 ± 0.20	1.50 ± 0.10
50287843	9	7.30 ± 0.25	1.50 ± 0.10
● 50153902	10	7.70 ± 0.20	1.50 ± 0.10
● 50287785	12	8.10 ± 0.20	1.50 ± 0.10

CROSS SECTION 1.0 mm² – AWG 18

Composition: 19 x 0.254 mm

Part number	No. of cores	Dimensions in mm	
		Outer-Ø	Core-Ø
● 50287781	2	5.30 ± 0.20	1.80 ± 0.10
● 50154600	3	5.60 ± 0.20	1.80 ± 0.10
● 50287779	4	6.10 ± 0.20	1.80 ± 0.10
● 50287768	5	6.60 ± 0.20	1.80 ± 0.10
● 50287759	6	7.20 ± 0.20	1.80 ± 0.10

MULTI-CONDUCTOR CABLES PVC

Unshielded UL-Style 2464

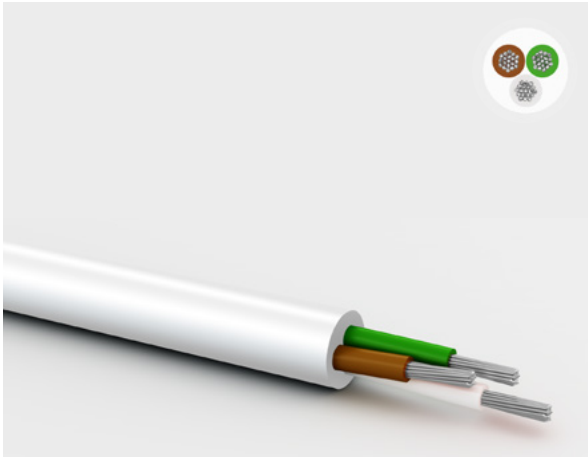

TECHNICAL DATA

Conductor	TPC – tin plated copper
Insulation	SR-PVC
Jacket / Color	PVC / White RAL 9003
Temperature range	-10 up to +80 °C
Test voltage	1,500 V/AC
Operating voltage UL	300 V
Flame retardant	UL VW-1 & CSA FT1
Wire colors	White / Yellow, White / Green, White / Red, White / Black, Violet, Gray, Orange, Brown, Blue, Yellow, Green, Red, Black, White

CROSS SECTION 0.08 mm² – AWG 28

Composition: 7 x 0.127 mm

Part number	No. of cores	Dimensions in mm	
		Outer-Ø	Core-Ø
● 50154327	6	4.40 ± 0.20	0.90 ± 0.08
● 50154329	7	4.30 ± 0.20	0.90 ± 0.08
● 50154331	8	4.60 ± 0.20	0.85 ± 0.08
● 50154333	9	5.00 ± 0.20	0.85 ± 0.08
● 50154334	10	5.00 ± 0.20	0.85 ± 0.08
● 50154335	12	5.00 ± 0.20	0.85 ± 0.08
● 50154336	14	5.50 ± 0.20	0.85 ± 0.08

CROSS SECTION 0.14 mm² – AWG 26

Composition: 7 x 0.16 mm

Part number	No. of cores	Dimensions in mm	
		Outer-Ø	Core-Ø
● 50154324	4	4.10 ± 0.20	1.00 ± 0.08
● 50154325	5	4.40 ± 0.20	1.00 ± 0.08
● 50154328	6	4.60 ± 0.20	1.00 ± 0.08
● 50154330	7	4.60 ± 0.20	0.90 ± 0.08
● 50154332	8	5.00 ± 0.20	1.00 ± 0.08

MULTI-CONDUCTOR CABLES PVC

Unshielded UL-Style 2464



CROSS SECTION 0.25 mm² – AWG 24

Composition: 7 x 0.20 mm

Part number	No. of cores	Dimensions in mm	
		Outer-Ø	Core-Ø
● 50154318	2	3.80 ± 0.15	1.10 ± 0.08
● 50154321	3	4.00 ± 0.15	1.10 ± 0.08

CROSS SECTION 0.34 mm² – AWG 22

Composition: 17 x 0.16 mm

Part number	No. of cores	Dimensions in mm	
		Outer-Ø	Core-Ø
● 50154317	2	4.10 ± 0.20	1.25 ± 0.08
● 50154322	3	4.60 ± 0.20	1.30 ± 0.08
● 50154323	4	4.50 ± 0.20	1.20 ± 0.08
● 50154326	5	4.90 ± 0.20	1.20 ± 0.08

CROSS SECTION 0.50 mm² – AWG 20

Composition: 26 x 0.16 mm

Part number	No. of cores	Dimensions in mm	
		Outer-Ø	Core-Ø
● 50154319	2	4.40 ± 0.20	1.40 ± 0.08
● 50154320	3	4.60 ± 0.20	1.40 ± 0.08

MULTI-CONDUCTOR CABLES PVC

Unshielded UL758



TECHNICAL DATA

Conductor	TPC – tin plated copper
Insulation	UL-PVC UL758
Temperature range	-10 up to +80 °C
Test voltage	2,000 V/AC
Operating voltage UL	300 V
Wire colors	Black, Brown, Red, Orange, Yellow, Green, Blue, Violet, Gray, White

CROSS SECTION 0.08 mm² – AWG 28

Composition: 7 x 0.127 mm

Part number	No. of cores	Dimensions in mm	
		Outer-Ø	Core-Ø
50519129	3	3.8	0.90
50519130	4	4.0	0.90
50519131	5	4.3	0.90
50519132	6	4.6	0.90
50519133	8	4.8	0.90
50519138	10	5.5	0.90

CROSS SECTION 0.14 mm² – AWG 26

Composition: 7 x 0.15 mm

Part number	No. of cores	Dimensions in mm	
		Outer-Ø	Core-Ø
50519184	3	4.0	1.00
50519185	4	4.3	1.00
50519186	5	4.6	1.00
50519187	6	4.9	1.00
50519188	8	5.2	1.00
50519189	10	5.9	1.00

ODU CABLE ASSEMBLY

At ODU, we recognize every industry is unique, and in order to meet the requirements of our customer applications, everything is developed and assembled inhouse.



MULTI-CONDUCTOR CABLES PVC

Shielded UL / cUL – LIYCY Style 2464 / 2517-10002



TECHNICAL DATA

Conductor	TPC – tin plated copper acc. to EN13602
Insulation	UL-PVC semi rigid
Jacket / Color	PVC / Black
Shielding	Copper braid tinned
Temperature range in motion	-10 up to +80 °C (style 2464) -10 up to +105 °C (style 2517)
Temperature range at rest	-30 up to +80 °C (style 2464) -30 up to +105 °C (style 2517)
Test voltage	1,500 V/AC
Operating voltage UL	300 V
Wire colors	acc. to IC-Code

CROSS SECTION 0.05 mm² – AWG 30

Composition: 7 x 0.102 mm

Part number	No. of cores	Dimensions in mm	
		Outer-Ø	Core-Ø
50287897	2	3.80 ± 0.20	0.90 ± 0.10
50287898	3	3.90 ± 0.20	0.90 ± 0.10
50287899	4	4.15 ± 0.20	0.90 ± 0.10

CROSS SECTION 0.08 mm² – AWG 28

Composition: 7 x 0.127 mm

Part number	No. of cores	Dimensions in mm	
		Outer-Ø	Core-Ø
50245221	2	4.00 ± 0.20	0.90 ± 0.10
50287833	3	4.10 ± 0.20	0.90 ± 0.10
50245223	4	4.30 ± 0.20	0.90 ± 0.10
● 50245225	6	4.85 ± 0.20	0.90 ± 0.10
● 50281762	10	5.80 ± 0.20	0.90 ± 0.10
50281763	14	6.20 ± 0.20	0.90 ± 0.10
50287818	16	6.50 ± 0.20	0.90 ± 0.10
50287896	26	8.70 ± 0.20	0.90 ± 0.10

CROSS SECTION 0.14 mm² – AWG 26

Composition: 7 x 0.160 mm

Part number	No. of cores	Dimensions in mm	
		Outer-Ø	Core-Ø
● 50245231	2	4.20 ± 0.20	1.00 ± 0.10
● 50245237	3	4.30 ± 0.20	1.00 ± 0.10
● 50153973	4	4.60 ± 0.20	1.00 ± 0.10
● 50153975	6	5.20 ± 0.20	1.00 ± 0.10
50287828	7	5.20 ± 0.20	1.00 ± 0.10
● 50153977	8	5.60 ± 0.20	1.00 ± 0.10
● 50245238	10	6.20 ± 0.20	1.00 ± 0.10
● 50153978	12	6.40 ± 0.20	1.00 ± 0.10

Part number	No. of cores	Dimensions in mm	
		Outer-Ø	Core-Ø
50287827	14	6.70 ± 0.20	1.00 ± 0.10
● 50153980	16	7.00 ± 0.20	1.00 ± 0.10
50153981	18	7.30 ± 0.20	1.00 ± 0.10
50287816	19	7.20 ± 0.20	1.00 ± 0.10
50153983	20	7.70 ± 0.20	1.00 ± 0.10
50153984	22	8.00 ± 0.20	1.00 ± 0.10
50287817	26	8.40 ± 0.20	1.00 ± 0.10
50153986	30	8.80 ± 0.20	1.00 ± 0.10

MULTI-CONDUCTOR CABLES PVC

Screened UL / cUL – LIYCY Style 2464 / 2517-10002



CROSS SECTION 0.34 mm² – AWG 22

Composition: 7 x 0.254 mm

Part number	No. of cores	Dimensions in mm	
		Outer-Ø	Core-Ø
● 50153988	2	4.80 ± 0.20	1.30 ± 0.10
● 50153989	3	4.90 ± 0.20	1.30 ± 0.10
● 50153990	4	5.30 ± 0.20	1.30 ± 0.10
50153991	5	5.80 ± 0.20	1.30 ± 0.10
● 50153992	6	6.20 ± 0.20	1.30 ± 0.10
50153994	8	6.70 ± 0.20	1.30 ± 0.10
50287824	10	7.50 ± 0.20	1.30 ± 0.10
50287820	12	7.80 ± 0.20	1.30 ± 0.10
50287825	14	8.00 ± 0.20	1.30 ± 0.10
50287826	16	8.60 ± 0.20	1.30 ± 0.10
● 50153999	18	8.70 ± 0.20	1.30 ± 0.10

CROSS SECTION 0.50 mm² – AWG 20

Composition: 7 x 0.320 mm

Part number	No. of cores	Dimensions in mm	
		Outer-Ø	Core-Ø
● 50154006	2	5.20 ± 0.20	1.50 ± 0.10
● 50154007	3	5.40 ± 0.20	1.50 ± 0.10
● 50154008	4	5.90 ± 0.20	1.50 ± 0.10
50287821	5	6.30 ± 0.20	1.50 ± 0.10
● 50154010	6	6.80 ± 0.20	1.50 ± 0.10
50287895	7	6.70 ± 0.20	1.50 ± 0.10
● 50154012	8	7.40 ± 0.20	1.50 ± 0.10
● 50154013	10	8.30 ± 0.20	1.50 ± 0.10

CROSS SECTION 1.0 mm² – AWG 18

Composition: 19 x 0.254 mm

Part number	No. of cores	Dimensions in mm	
		Outer-Ø	Core-Ø
● 50287892	3	6.10 ± 0.20	1.80 ± 0.10
● 50287893	4	6.60 ± 0.20	1.80 ± 0.10
50287894	7	7.90 ± 0.20	1.80 ± 0.10

CROSS SECTION 2.5 mm² – AWG 14

Composition: 41 x 0.254 mm

Part number	No. of cores	Dimensions in mm	
		Outer-Ø	Core-Ø
50287813	2	8.40 ± 0.20	3.00 ± 0.10
50287872	3	8.80 ± 0.20	3.00 ± 0.10
50287891	4	9.10 ± 0.20	3.00 ± 0.10

MULTI-CONDUCTOR CABLES PVC

Shielded UL758



TECHNICAL DATA

Conductor	TPC – tin plated copper
Insulation	UL-PVC UL758
Shielding	Copper braid tinned, 80 % cover
Temperature range	-10 up to +80 °C
Test voltage	2,000 V/AC
Operating voltage	300 V
Wire colors	Black, Brown, Red, Orange, Yellow, Green, Blue, Violet, Gray, White

CROSS SECTION 0.08 mm² – AWG 28

Composition: 7 x 0.127 mm

Part number	No. of cores	Dimensions in mm	
		Outer-Ø	Core-Ø
50519190	3	4.10	0.90
50519191	4	4.30	0.90
50519192	5	4.60	0.90
50519193	6	4.80	0.90
50519194	8	5.10	0.90
50519195	10	5.70	0.90

CROSS SECTION 0.14 mm² – AWG 26

Composition: 7 x 0.15 mm

Part number	No. of cores	Dimensions in mm	
		Outer-Ø	Core-Ø
50519196	3	4.30	1.00
50519197	4	4.50	1.00
50519198	5	4.80	1.00
50519199	6	5.20	1.00
50519200	8	5.50	1.00
50519201	10	6.20	1.00

MINIATURE MULTI-CONDUCTOR CABLES PVC

Shielded LiFYDY – without UL approval

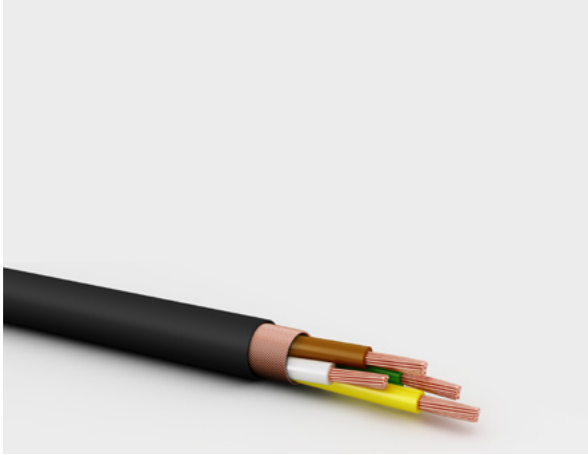

TECHNICAL DATA

Conductor	Bare copper, fine wire
Insulation	PVC acc. to VDE 0207
Shielding	Copper spiral shielding
Temperature range in motion	-5 up to +70 °C
Temperature range at rest	-20 up to +70 °C
Test voltage (0.05 / 0.10 mm ²)	500 / 900 V/AC
Operating voltage (0.05 / 0.10 mm ²)	100 / 300 V
Wire colors	acc. to DIN 47100

CROSS SECTION 0.05 mm² – AWG 30

Composition: 26 x 0.05 mm

Part number	No. of cores	Dimensions in mm Outer-Ø
● 50245241	2	2.70 ± 0.20
● 50245242	3	2.80 ± 0.20
● 50245243	4	3.00 ± 0.20
● 50245244	5	3.20 ± 0.20
● 50245246	7	3.40 ± 0.20
● 50245247	8	3.70 ± 0.20
● 50245248	12	4.50 ± 0.20
● 50245249	16	4.80 ± 0.20

CROSS SECTION 0.10 mm² – AWG 28

Composition: 51 x 0.05 mm

Part number	No. of cores	Dimensions in mm Outer-Ø
● 50245250	2	3.60 ± 0.20
● 50245251	3	3.70 ± 0.20
● 50245252	4	4.00 ± 0.20
● 50245254	7	4.60 ± 0.20
● 50245255	8	4.90 ± 0.20
● 50245256	12	5.70 ± 0.20
● 50245257	16	6.00 ± 0.20

MINIATURE MULTI-CONDUCTOR CABLES PVC

Shielded UL approved – UL-LifYDY / Style 2936

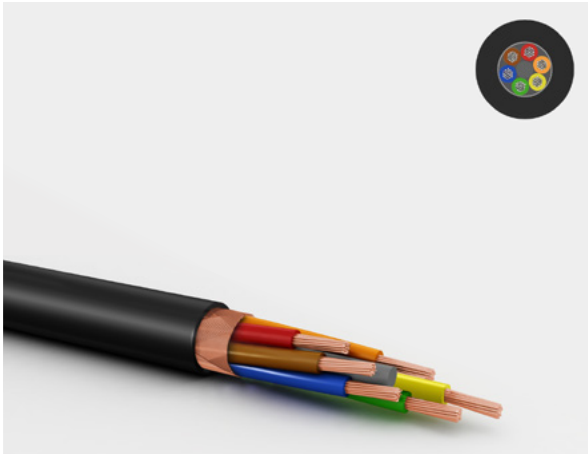

TECHNICAL DATA

Conductor	Bare copper, fine wire
Insulation	SR-PVC
Shielding	Copper spiral shielding
Temperature range in motion	-10 up to +80 °C
Temperature range at rest	-30 up to +80 °C
Test voltage	1,000 V/AC
Operating voltage	150 V
Wire colors	acc. to IC-Code

CROSS SECTION 0.08 mm² – AWG 28

Composition: 40 x 0.05 mm

Part number	No. of cores	Dimensions in mm Outer-Ø
● 50245288	2	2.90 ± 0.20
● 50245289	3	3.00 ± 0.20
● 50245290	4	3.20 ± 0.20
● 50245291	5	3.50 ± 0.20
● 50245292	8	4.10 ± 0.20

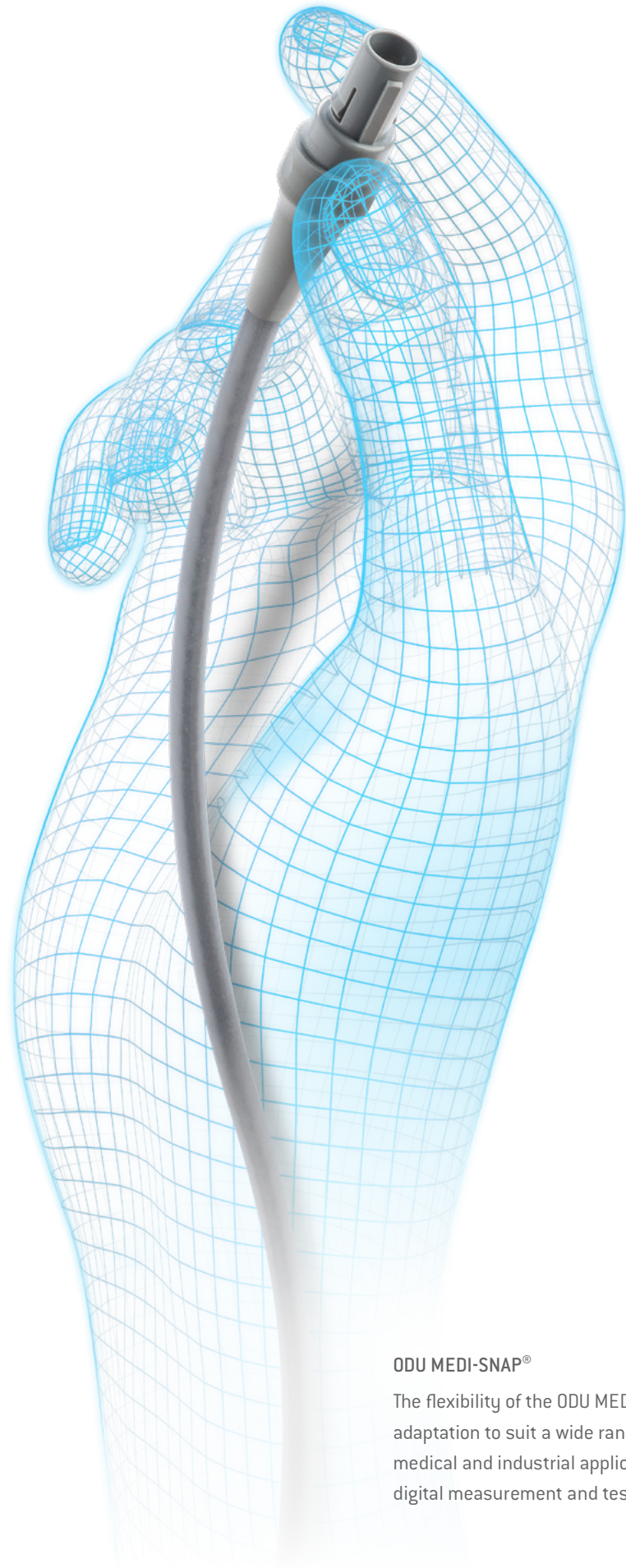

ODU MEDI-SNAP®

The flexibility of the ODU MEDI-SNAP® series allows adaptation to suit a wide range of requirements in medical and industrial applications as well as in the digital measurement and testing sector.

MULTI-CONDUCTOR CABLES, PUR

Unshielded UL / cUL – Style 20233 / 10042

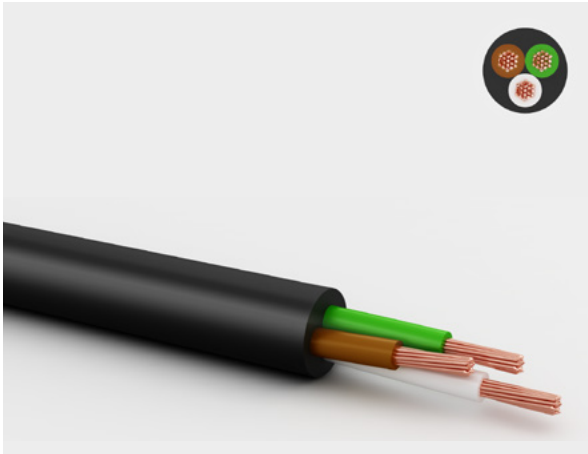

TECHNICAL DATA

Conductor	Bare copper acc. to EN13602
Insulation	TPE (12Y) thermoplastic compound
Jacket / Color	PUR – (11Y), UL-AWM758 / Black
Temperature range in motion	–40 up to +80 °C
Temperature range at rest	–50 up to +80 °C
Test voltage	1,500 V/AC
Operating voltage UL	300 V
Wire colors	acc. to DIN 47100

CROSS SECTION 0.08 mm² – AWG 28

Composition: 10 x 0.10 mm

Part number	No. of cores	Dimensions in mm	
		Outer-Ø	Core-Ø
50287799	9	5.50 ± 0.20	0.90 ± 0.05
● 50154023	10	5.30 ± 0.25	0.90 ± 0.05
● 50287832	12	5.50 ± 0.25	0.90 ± 0.05
● 50154024	14	5.70 ± 0.20	0.90 ± 0.05
● 50289941	20	6.80 ± 0.30	0.90 ± 0.05
● 50287798	26	7.30 ± 0.20	0.90 ± 0.05

CROSS SECTION 0.14 mm² – AWG 26

Composition: 18 x 0.10 mm

Part number	No. of cores	Dimensions in mm	
		Outer-Ø	Core-Ø
● 50154025	4	4.00 ± 0.20	0.95 ± 0.10
● 50289935	5	4.30 ± 0.20	0.95 ± 0.10
● 50154027	6	4.55 ± 0.20	0.95 ± 0.10
50287858	7	4.85 ± 0.20	0.95 ± 0.10
● 50154029	8	5.25 ± 0.25	0.95 ± 0.10
50287860	12	5.90 ± 0.25	0.95 ± 0.10
● 50154032	16	6.10 ± 0.20	0.95 ± 0.10
● 50287903	19	6.65 ± 0.20	0.95 ± 0.10
● 50287790	26	7.60 ± 0.20	0.95 ± 0.10

MULTI-CONDUCTOR CABLES, PUR

Unshielded UL / cUL – Style 20233 / 10042



CROSS SECTION 0.34 mm² – AWG 22

Composition: 19 x 0.150 mm

Part number	No. of cores	Dimensions in mm	
		Outer-Ø	Core-Ø
● 50154042	4	4.75 ± 0.20	1.30 ± 0.10
● 50287855	5	5.10 ± 0.30	1.30 ± 0.10
● 50154047	10	6.60 ± 0.25	1.30 ± 0.10
● 50289940	14	7.70 ± 0.40	1.30 ± 0.05
● 50154053	20	8.50 ± 0.30	1.30 ± 0.10

CROSS SECTION 0.50 mm² – AWG 20

Composition: 28 x 0.150 mm

Part number	No. of cores	Dimensions in mm	
		Outer-Ø	Core-Ø
● 50287852	2	4.70 ± 0.20	1.50 ± 0.10
● 50154059	3	4.95 ± 0.20	1.50 ± 0.10
● 50154060	4	5.35 ± 0.25	1.50 ± 0.10
● 50154062	6	6.20 ± 0.25	1.50 ± 0.10

CROSS SECTION 0.75 mm² – AWG 19

Composition: 42 x 0.15 mm

Part number	No. of cores	Dimensions in mm	
		Outer-Ø	Core-Ø
● 50289936	3	5.70 ± 0.20	1.80 ± 0.10
● 50289937	4	6.30 ± 0.20	1.80 ± 0.10
● 50289938	5	6.70 ± 0.25	1.80 ± 0.10

MULTI-CONDUCTOR CABLES PUR

Shielded-UL / cUL – Style 20233 / 10042

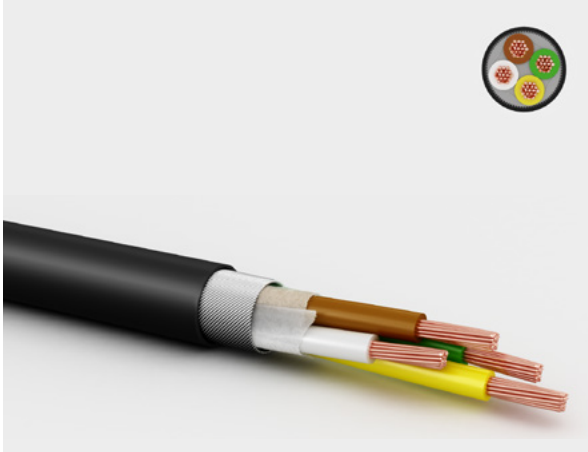

TECHNICAL DATA

Conductor	Bare copper acc. to EN13602
Insulation	TPE (12Y) thermoplastic compound
Jacket / Color	PUR – (11Y), UL-AWM758 / Black
Temperature range in motion	–40 up to +80 °C
Temperature range at rest	–50 up to +80 °C
Test voltage	1,500 V/AC
Operating voltage UL	300 V
Wire colors	acc. to DIN 47100

CROSS SECTION 0.08 mm² – AWG 28

Composition: 10 x 0.10 mm

Part number	No. of cores	Dimensions in mm	
		Outer-Ø	Core-Ø
50154236	2	2.70 ± 0.20	0.90 ± 0.05
50154237	3	4.00 ± 0.20	0.90 ± 0.05
50287839	4	4.20 ± 0.20	0.90 ± 0.05
50289944	5	4.50 ± 0.20	0.90 ± 0.05
● 50287840	6	4.65 ± 0.20	0.90 ± 0.05
● 50287841	7	4.95 ± 0.20	0.90 ± 0.05
50289946	8	5.60 ± 0.20	0.90 ± 0.05
● 50281766	9	5.60 ± 0.20	0.90 ± 0.05
● 50153919	10	5.50 ± 0.20	0.90 ± 0.05
● 50153920	14	6.00 ± 0.20	0.90 ± 0.05
50306140	19	6.80 ± 0.20	0.90 ± 0.07
50306141	20	6.80 ± 0.20	0.90 ± 0.07
50289942	26	7.30 ± 0.20	0.90 ± 0.05

CROSS SECTION 0.14 mm² – AWG 26

Composition: 18 x 0.10 mm

Part number	No. of cores	Dimensions in mm	
		Outer-Ø	Core-Ø
● 50153921	4	4.20 ± 0.25	0.95 ± 0.10
● 50153922	5	4.70 ± 0.25	0.95 ± 0.10
● 50153923	6	5.00 ± 0.25	0.95 ± 0.10
● 50153925	8	5.60 ± 0.25	0.95 ± 0.10
50287838	9	5.80 ± 0.25	0.95 ± 0.10
50153926	12	6.20 ± 0.25	0.95 ± 0.10
50153927	14	6.10 ± 0.25	0.95 ± 0.10
● 50153928	16	6.30 ± 0.25	1.00 ± 0.10
50153929	18	7.20 ± 0.25	1.00 ± 0.10
● 50153930	19	7.80 ± 0.25	1.00 ± 0.10
50153931	20	7.00 ± 0.25	1.00 ± 0.10
● 50153932	22	7.45 ± 0.25	1.00 ± 0.10
● 50153933	26	9.20 ± 0.25	1.00 ± 0.10
● 50153934	30	7.90 ± 0.25	1.00 ± 0.10
50306135	40	9.10 ± 0.20	0.95 ± 0.10

MULTI-CONDUCTOR CABLES PUR

Shielded D-UL / cUL – Style 20233 / 10042



CROSS SECTION 0.34 mm² – AWG 22

Composition: 19 x 0.15 mm

Part number	No. of cores	Dimensions in mm	
		Outer-Ø	Core-Ø
● 50153936	2	4.50 ± 0.25	1.30 ± 0.15
● 50153937	3	4.60 ± 0.25	1.30 ± 0.15
● 50153938	4	5.10 ± 0.25	1.30 ± 0.15
● 50153939	5	5.40 ± 0.25	1.30 ± 0.15
● 50153940	6	5.80 ± 0.25	1.30 ± 0.15
● 50153941	7	6.05 ± 0.25	1.30 ± 0.15
● 50153942	8	6.70 ± 0.20	1.30 ± 0.15
● 50153943	10	7.00 ± 0.25	1.30 ± 0.15
● 50306139	11	7.50 ± 0.20	1.30 ± 0.07
50153945	14	7.45 ± 0.35	1.30 ± 0.15
50153946	16	8.00 ± 0.35	1.30 ± 0.15
● 50281765	18	8.15 ± 0.35	1.30 ± 0.15
50306136	24	9.80 ± 0.30	1.30 ± 0.07
50306138	27	10.20 ± 0.40	1.30 ± 0.07

CROSS SECTION 0.50 mm² – AWG 20

Composition: 28 x 0.15 mm

Part number	No. of cores	Dimensions in mm	
		Outer-Ø	Core-Ø
● 50153954	2	4.90 ± 0.20	1.50 ± 0.10
● 50153955	3	5.15 ± 0.25	1.50 ± 0.10
● 50153956	4	5.55 ± 0.25	1.50 ± 0.10
50153957	5	5.95 ± 0.25	1.50 ± 0.10
● 50153958	6	6.40 ± 0.25	1.50 ± 0.10
50153959	7	6.85 ± 0.25	1.50 ± 0.10
● 50153960	8	7.45 ± 0.25	1.50 ± 0.10
● 50153961	10	7.75 ± 0.25	1.50 ± 0.10

CROSS SECTION 0.75 mm² – AWG 19

Composition: 42 x 0.15 mm

Part number	No. of cores	Dimensions in mm	
		Outer-Ø	Core-Ø
50287977	3	6.15 ± 0.20	1.95 ± 0.10
50287975	4	6.70 ± 0.20	1.95 ± 0.10
50287972	7	8.35 ± 0.20	1.95 ± 0.10

CROSS SECTION 2.5 mm² – AWG 14

Composition: 50 x 0.25 mm

Part number	No. of cores	Dimensions in mm	
		Outer-Ø	Core-Ø
50287966	2	7.50 ± 0.20	2.80 ± 0.10
50287967	3	8.00 ± 0.20	2.80 ± 0.10
50287968	4	9.65 ± 0.20	2.80 ± 0.10

MINIATURE SENSOR CABLES PUR

Unshielded without UL approval

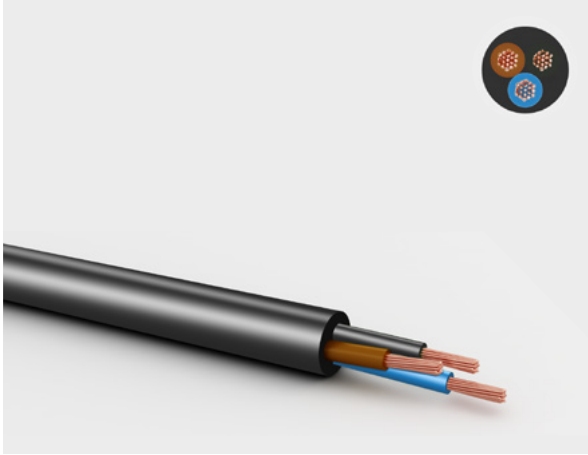

TECHNICAL DATA

Conductor	Bare copper, fine wire acc. to DIN VDE 0295
Insulation	PVC
Jacket / Color	PUR / Black
Temperature range in motion	-15 up to +80 °C
Temperature range at rest	-30 up to +80 °C
Test voltage	1,200 V/AC
Operating voltage UL	300 V
Wire colors	Brown, Blue, Black, White, Green 8 wires acc. to DIN47100

CROSS SECTION 0.09 mm² – AWG 28

Composition: 19 x 0.079 mm

Part number	No. of cores	Dimensions in mm Outer-Ø
● 50245156	3	2.40
● 50245158	4	2.60
● 50245159	5	2.90
● 50245160	8	3.40

MINIATURE SENSOR CABLES PUR

Shielded without UL approval

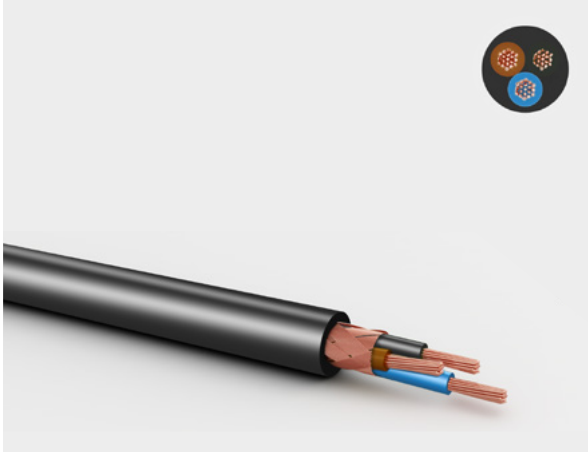

TECHNICAL DATA

Conductor	Bare copper, fine wire acc. to DIN VDE 0295
Insulation	PVC
Jacket / Color	PUR / Black
Shielding	Copper spiral shield
Temperature range in motion	-10 up to +80 °C
Temperature range at rest	-30 up to +80 °C
Test voltage	1,200 V/AC
Operating voltage UL	300 V
Wire colors	Brown, Blue, Black, White, Green 8 wires acc. to DIN47100

CROSS SECTION 0.09 mm² – AWG 28

Composition: 19 x 0.079 mm

Part number	No. of cores	Dimensions in mm Outer-Ø
● 50245172	3	2.80
● 50245173	4	2.90
● 50245174	5	3.10
● 50245175	8	3.60

ODU AMC® PREFERENCE CABLE

UL-Style 20233 / 10042

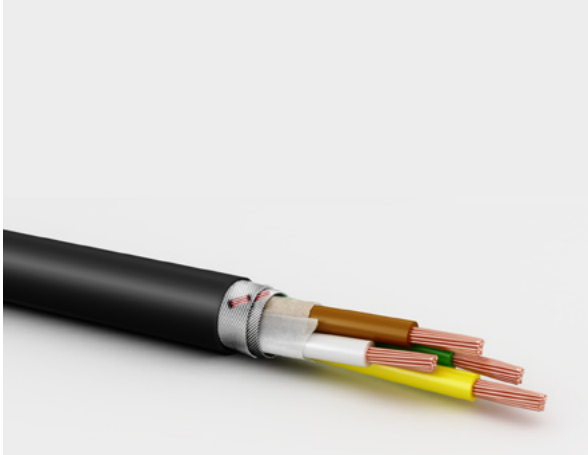

TECHNICAL DATA

Conductor	Bare copper acc. to EN13602
Insulation	TPE (12Y) thermoplastic compound
Jacket / Color	PUR – (11Y), UL-AWM758 / Black
Shielding	Double round crossed twist (DD++)
Temperature range in motion	–40 up to +80 °C
Temperature range at rest	–50 up to +80 °C
Test voltage	1,500 V/AC
Operating voltage UL	300 V
Wire colors	acc. to DIN 47100

CROSS SECTION 0.08 mm² – AWG 28

Composition: 10 x 0.10 mm

Part number	No. of cores	Dimensions in mm	
		Outer-Ø	Core-Ø
● 50154238	4	4.40 ± 0.20	0.90 ± 0.05
● 50153918	7	5.20 ± 0.20	0.90 ± 0.05
● 50154292	16	6.40 ± 0.20	0.90 ± 0.05
● 50154609	27	8.00 ± 0.20	0.90 ± 0.05

CROSS SECTION 0.25 mm² – AWG 24

Composition: 41 x 0.078 mm

Part number	No. of cores	Dimensions in mm	
		Outer-Ø	Core-Ø
● 50154633	2	4.50 ± 0.20	1.10 ± 0.05

CROSS SECTION MIXED

Composition: see table

Test voltage: 2,000 V/AC

Part number	Composition	Dimensions in mm	
		Outer-Ø	Core-Ø
● 50154634	6 x AWG 22 / 1 x AWG 28 / 1 x (2 x AWG 28)	7.10 ± 0.25	AWG 22: 1.30 ± 0.05 AWG 28: 1.20 ± 0.10 AWG 28 (pair): 0.85 ± 0.05

SILICONE CABLES¹

Reference standard: UL-Style 758 / 1581

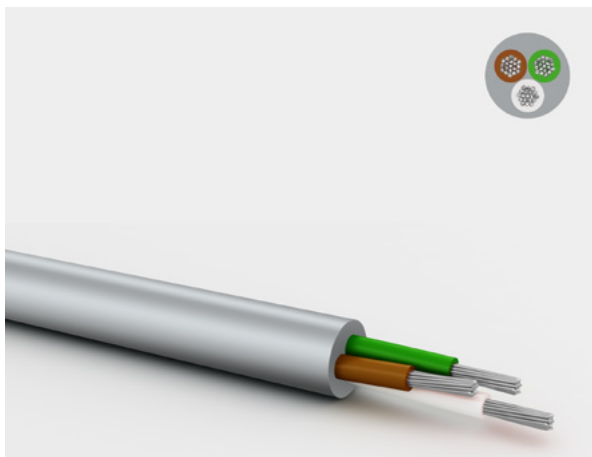

TECHNICAL DATA

Conductor	TPC – tin plated copper
Insulation	FEP
Jacket / Color	Silicone / Gray, RAL7045
Temperature range	–60 up to +200 °C
Test voltage	2,000 V/AC
Operating voltage UL	300 V
Characteristics	Wipe disinfectable EtO sterilizable
Wire colors	White, Black, Red, Yellow, Green, Blue

CROSS SECTION 0.08 mm² – AWG 28

Composition: 7 x 0.12 mm

Part number	No. of cores	Dimensions in mm	
		Outer-Ø	Core-Ø
● 50154316	6	4.40 ± 0.15	0.96 ± 0.10

CROSS SECTION 0.14 mm² – AWG 26

Composition: 7 x 0.16 mm

Part number	No. of cores	Dimensions in mm	
		Outer-Ø	Core-Ø
● 50154314	4	4.10 ± 0.15	1.07 ± 0.10
● 50154315	5	4.40 ± 0.15	1.07 ± 0.10

CROSS SECTION 0.34 mm² – AWG 22

Composition: 19 x 0.15 mm

Part number	No. of cores	Dimensions in mm	
		Outer-Ø	Core-Ø
● 50154312	2	4.40 ± 0.15	1.44 ± 0.10
● 50154313	3	4.60 ± 0.15	1.44 ± 0.10

¹ Not used for silicone-overmolded system solutions.

HIGH-VOLTAGE CABLE

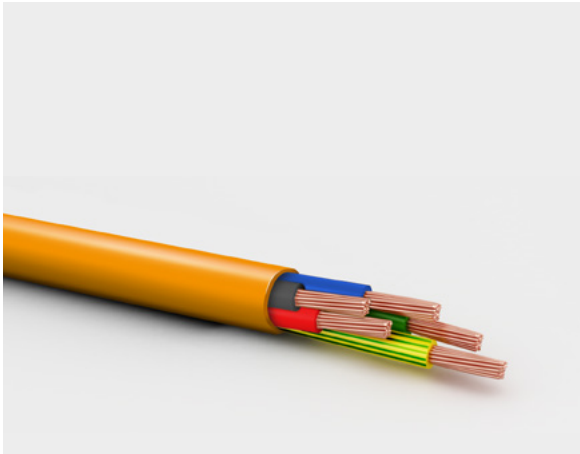

TECHNICAL DATA

Conductor	Bare copper
Insulation	PP UL 1581
Jacket / Color	PUR UL 1581 / Orange
Temperature range in motion	-25 up to +80 °C
Temperature range at rest	-40 up to +80 °C
Test voltage	4,000 V/AC
Operating voltage UL	600 V / 1,000 V (50 Hz)
Characteristics	Halogen free acc. to IEC 60754-1; EN 50267-2-1 Oilresistant acc. to 60811-2-1
Wire colors	Red, Black, Blue, Green, Green-Yellow

CROSS SECTION 1.00 mm² – AWG 18

Composition: 32 x 0.20 mm

Part number	No. of cores	Dimensions in mm	
		Outer-Ø	Core-Ø
● 50285050	5	8.30 ± 0.30	2.10



HIGH-VOLTAGE SINGLE WIRE



TECHNICAL DATA

Conductor	SPC – silver plated copper
Insulation	Fp-FEP
Temperature range	-40 up to +200 °C
Test voltage	13,100 V/AC
Operating voltage UL	5,800 V

CROSS SECTION 1.00 mm² / AWG 18

Composition: 19 x 0.12 mm

Part number	Color	Wire-Ø in mm
50303790	Orange	2.45

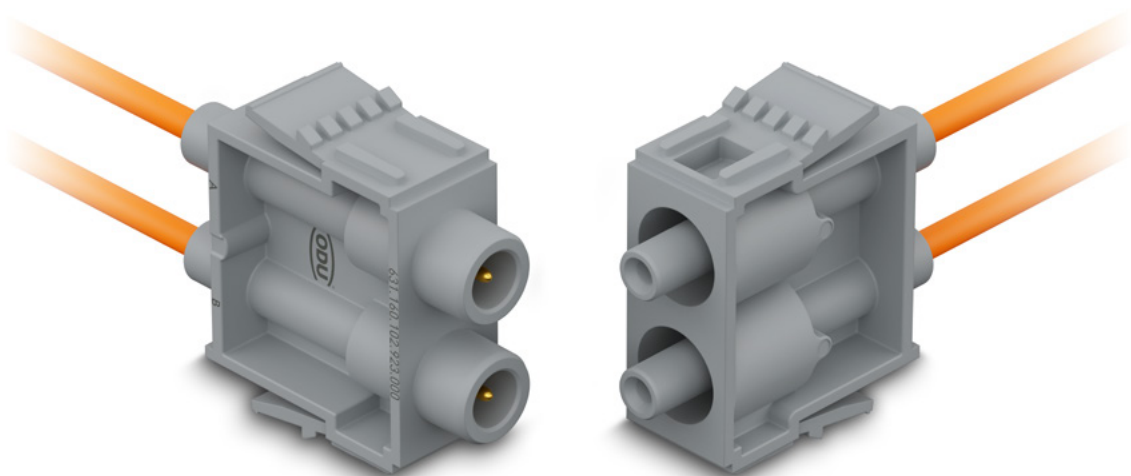

FLAT RIBBON CABLES

UL-Style 2678 AWG 30 / Pattern 0.635 mm FBL LIY

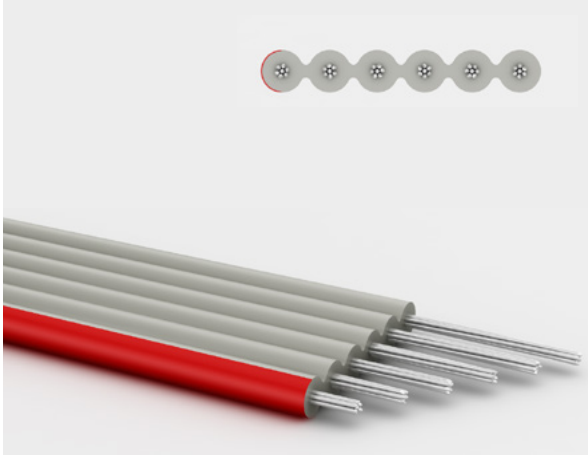

TECHNICAL DATA

Conductor	TPC – tin plated copper acc. to EN13602
Insulation	UL-PVC semi rigid
Temperature range in motion	-10 up to +105 °C
Temperature range at rest	-30 up to +105 °C
Test voltage	1,500 V/AC
Operating voltage UL	30 V

CROSS SECTION 0.09 mm² – AWG 30

Composition: 7 x 0.102 mm

Wall thickness of insulation: 0.23 mm

Part number	No. of cores	Dimensions in mm	
		Height	Width
50234717	9	0.64 ± 0.05	5.72 ± 0.15
● 50234718	10	0.64 ± 0.05	6.36 ± 0.15
50234719	14	0.64 ± 0.05	8.90 ± 0.15
50234720	15	0.64 ± 0.05	9.53 ± 0.15
50234721	16	0.64 ± 0.05	10.17 ± 0.20
● 50234722	20	0.64 ± 0.05	12.71 ± 0.20
50234723	25	0.64 ± 0.05	15.88 ± 0.25

Part number	No. of cores	Dimensions in mm	
		Height	Width
50234724	26	0.64 ± 0.05	16.52 ± 0.25
50234726	34	0.64 ± 0.05	21.62 ± 0.30
50234727	37	0.64 ± 0.05	23.50 ± 0.30
● 50234728	40	0.64 ± 0.05	25.41 ± 0.30
● 50234729	50	0.64 ± 0.05	31.76 ± 0.40
50234730	60	0.64 ± 0.05	38.11 ± 0.40

FLAT RIBBON CABLES

UL-Style 2651 AWG 28 / Pattern 1.27 mm FBL LIY

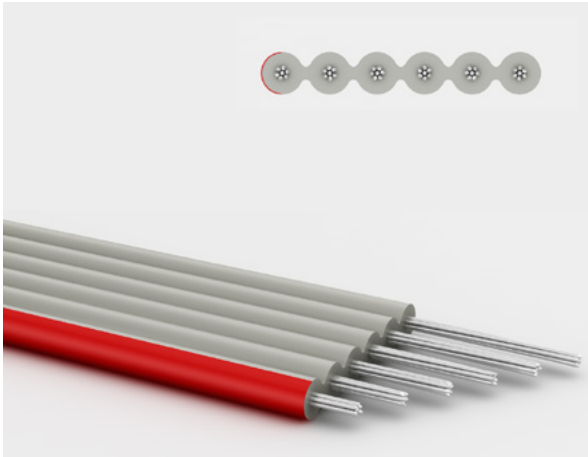

TECHNICAL DATA

Conductor	TPC – tin plated copper acc. to EN13602
Insulation	UL-PVC 105 °C
Temperature range in motion	-10 up to +105 °C
Temperature range at rest	-30 up to +105 °C
Test voltage	2,000 V/AC
Operating voltage UL	300 V

CROSS SECTION 0.08 mm² – AWG 28

Composition: 7 x 0.127 mm

Wall thickness of insulation: 0.23 mm

Part number	No. of cores	Dimensions in mm	
		Height	Width
● 50157201	9	0.93 ± 0.05	11.09 ± 0.20
● 50157202	10	0.93 ± 0.05	12.36 ± 0.20
● 50157204	14	0.93 ± 0.05	17.44 ± 0.20
50157205	15	0.93 ± 0.05	18.71 ± 0.20
50157206	16	0.93 ± 0.05	19.98 ± 0.20
● 50157207	20	0.93 ± 0.05	25.06 ± 0.20
50157208	25	0.93 ± 0.05	31.41 ± 0.25

Part number	No. of cores	Dimensions in mm	
		Height	Width
● 50157209	26	0.93 ± 0.05	32.68 ± 0.25
50157210	34	0.93 ± 0.05	42.84 ± 0.30
50157211	37	0.93 ± 0.05	46.65 ± 0.30
● 50157212	40	0.93 ± 0.05	50.46 ± 0.40
● 50157213	50	0.93 ± 0.05	63.16 ± 0.50
50157214	60	0.93 ± 0.05	75.86 ± 0.50
● 50157215	64	0.93 ± 0.05	80.94 ± 0.50

FLAT RIBBON CABLES

UL-Style 2651 AWG 26 / Pattern 1.27 mm FBL LIY

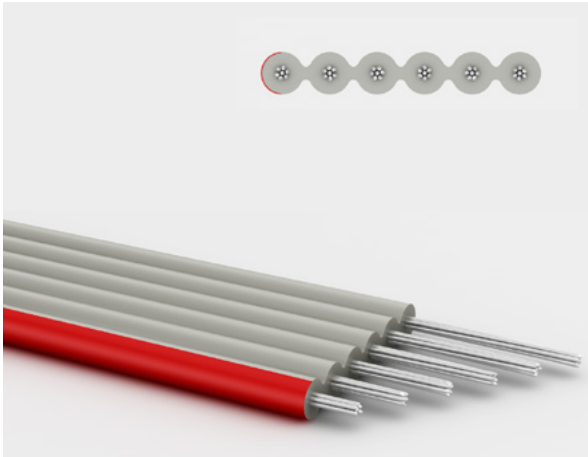

TECHNICAL DATA

Conductor	TPC – tin plated copper acc. to EN13602
Insulation	UL-PVC 105 °C
Temperature range in motion	-10 up to +105 °C
Temperature range at rest	-30 up to +105 °C
Test voltage	2,000 V/AC
Operating voltage UL	300 V

CROSS SECTION 0.14 mm² – AWG 26

Composition: 7 x 0.160 mm

Wall thickness of insulation: 0.23 mm

Part number	No. of cores	Dimensions in mm	
		Height	Width
50157216	10	1.00 ± 0.05	12.43 ± 0.20
● 50157217	14	1.00 ± 0.05	17.51 ± 0.20
50157218	16	1.00 ± 0.05	20.05 ± 0.20
50157219	20	1.00 ± 0.05	25.13 ± 0.20
50157220	25	1.00 ± 0.05	31.48 ± 0.25
50157221	26	1.00 ± 0.05	32.75 ± 0.25

Part number	No. of cores	Dimensions in mm	
		Height	Width
50157222	34	1.00 ± 0.05	42.91 ± 0.30
50157223	37	1.00 ± 0.05	46.72 ± 0.30
50157224	40	1.00 ± 0.05	50.53 ± 0.40
50157225	50	1.00 ± 0.05	63.23 ± 0.50
50157226	60	1.00 ± 0.05	75.67 ± 0.50
● 50157227	64	1.00 ± 0.05	81.01 ± 0.50



ODU AMC®

ODU AMC® is a rugged miniature connector solution for extreme environments. The connectors are waterproof when mated and unmated, offer robust mechanical coding with a visual indicator, and are EMI shielded.

COAXIAL CABLES



TECHNICAL DATA

Conductor	See table
Insulation	See table
Jacket / Color	PVC / Black FEP-6Y / Transparent PFA-51Y / White
Shielding	Copper spiral shield
Temperature range in motion	See table
Temperature range at rest	See table

WITHOUT UL APPROVAL

Part number	RG-Type	Z	Temperature range (motion/rest)	Conductor	Dimensions in mm		Insulation Jacket
					Outer-Ø	Core-Ø	
● 50154255	RG58	50 Ω	-40 °C / +80 °C (r)	tin-plated copper	4.95 ± 0.12	2.95	PVC
● 50153690	RG59	75 Ω	-20 °C / +70 °C (r)	steel-copper – conductor blank	6.15 ± 0.20	3.70 ± 0.10	PVC
● 50154612	RG142	50 Ω	-70 °C / +200 °C (m)	steel-copper – silver-plated conductor	4.95 ± 0.15	2.95 ± 0.10	FEP-6Y
● 50153783	RG174	50 Ω	-10 °C / +70 °C (m)	steel-copper – conductor blank	2.80 ± 0.13	1.50 ± 0.08	PVC
● 50154086	RG178	50 Ω	-55 °C / +200 °C (m)	steel-copper – silver-plated conductor	1.80 ± 0.10	0.84 ± 0.05	FEP-6Y
● 50153706	RG179	75 Ω	-55 °C / +200 °C (m)	steel-copper – silver-plated conductor	2.54 ± 0.10	1.60 ± 0.05	FEP-6Y
● 50153757	RG187	75 Ω	-55 °C / +200 °C (m)	steel-copper – silver-plated conductor	2.54 ± 0.15	1.60 ± 0.10	PFA-51Y
● 50284084	RG188	50 Ω	-55 °C / +200 °C (m)	steel-copper – silver-plated conductor	2.59 ± 0.10	1.52 ± 0.05	PFA-51Y
● 50284079	RG196	50 Ω	-55 °C / +200 °C (r)	steel-copper – silver-plated conductor	1.94	0.84	PTFE-5Y
● 50154244	RG223	50 Ω	-30 °C / +70 °C (m)	silver-plated copper acc. to EN13602	5.40 ± 0.20	2.95 ± 0.10	PVC
● 50154305	RG316	50 Ω	-55 °C / +200 °C (m)	steel-copper – silver-plated conductor	2.50 ± 0.10	1.52 ± 0.05	FEP-6Y
● 50154644	RG316	50 Ω	-55 °C / +200 °C (m)	steel-copper – silver-plated conductor	2.90 ± 0.10	1.52 ± 0.05	FEP-6Y

COAXIAL CONNECTORS



SMA (MALE)

Contact type: Pin
 Connection type: Solder, Crimp

Part number	RG-Type	Matching Cables
● 50158488	58	50154255
	142	50154612
	223	50154244
● 50158484	178	50154086
	196	50284079
● 50158485	174	50153783
	188	50284084
	316	50154305
● 50289806	316 D	50154644

BNC (MALE)

Contact type: Pin
 Connection type: Crimp, Crimp

Part number	RG-Type	Matching Cables
● 50252732	58	50154255
● 50256563	59	50153690
● 50283318	142	50154612
● 50277576	174	50153783
	188	50284084
	316	50154305
● 50283325	178	50154086
	196	50284079
● 50158363	179	50153706
	187	50153757
● 50283327	223	50154244
● 50289805	316 D	50154644

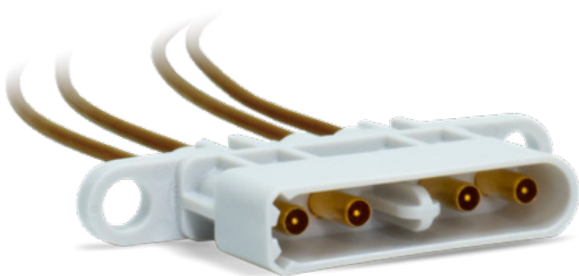

ODU-MAC® SPLIT COIL CONNECTOR

4 position flexible docking connector with integrated pre-guiding system for ± 0.25 mm tolerance compensation.

USB® CABLES

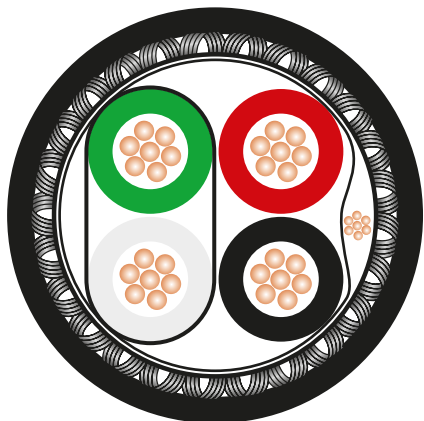

TECHNICAL DATA USB® 2.0

Conductor	Stranded tinned copper wire
Composition	1 x 2 x AWG 28 2 x AWG 28
UL-Style	20963
Stranding	2 cores stranded to a pair
Jacket / Color	TPU / Black
Insulation	PVC Ø 0.80 mm PE Ø 0.84 mm
Shielding	Tinned copper Ø 0.13 mm
Features	Oil resistant according to UL 758 Sec.15 (60 °C)

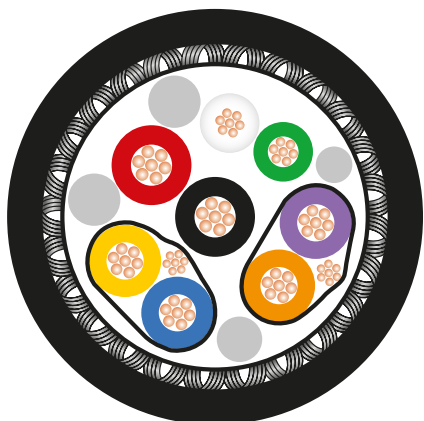

TECHNICAL DATA USB® 3.2 GEN 1x1

Conductor	Stranded tinned copper wire
Composition	2 x 2 x AWG 28 1 x 2 x AWG 28 2 x AWG 24
UL-Style	20963
Stranding	2 cores stranded to a pair
Jacket / Color	PUR / Black
Insulation	PE Ø 1.10 mm PE Ø 1.00 mm PE Ø 0.75 mm
Shielding	Tinned copper Ø 0.13 mm
Features	Halogen free acc. to IEC60754

BY THE METER

Part number	Cores	Type and Configuration	Dimensions in mm Outer-Ø
● 50154487	4	USB® 2.0 (480 Mbit/s)	4.20 ± 0.20
● 50154632	8	USB® 3.2 Gen1x1 (5Gbit/s)	5.70 ± 0.20

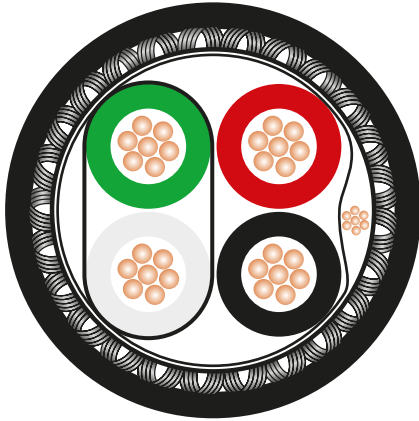

DATA CABLES USB® 2.0



TECHNICAL DATA

	PRE-ASSEMBLED – TYPE A	PRE-ASSEMBLED – TYPE MICRO B
Conductor	Stranded copper wire	Stranded copper wire
Composition	1 x 2 x AWG 28 2 x AWG 24	1 x 2 x AWG 28 2 x AWG 28
Jacket / Color	PVC / Black	PVC / Black
Temperature range	-15 up to +80 °C	-15 up to +80 °C
Test voltage	100 V	300 V

PRE-ASSEMBLED – TYPE A

Part number	Cores	Type and Configuration	Dimensions in mm Outer-Ø	Length (m)	
● 50154619	4	USB® 2.0 (480 Mbit/s) Plug A – Plug A	4.50	1.50	
● 50154628				3.00	
● 50154417	4	USB® 2.0 (480 Mbit/s) Plug A – Socket A	4.50	1.80	
● 50154519				3.00	

PRE-ASSEMBLED – TYPE MICRO B

Part number	Cores	Type and Configuration	Dimensions in mm Outer-Ø	Length (m)	
● 50154621	4	USB® 2.0 (480 Mbit/s) Plug A – Micro-Plug B	4.50	1.80	

DATA CABLES USB® 3.2 GEN 1x1

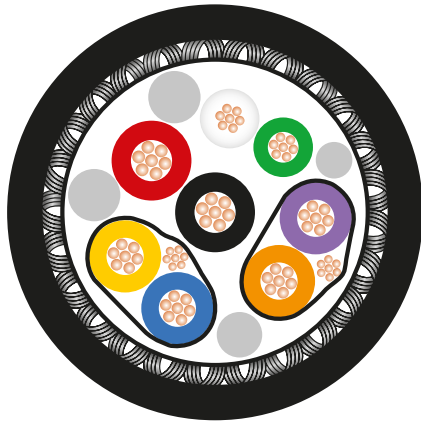

TECHNICAL DATA

	PRE-ASSEMBLED – TYPE A	PRE-ASSEMBLED – TYPE MICRO B
Conductor	Stranded copper wire	Stranded copper wire
Composition	2 x 2 x AWG 28 1 x 2 x AWG 28 2 x AWG 24	2 x 2 x AWG 28 1 x 2 x AWG 28 2 x AWG 24
UL-Style	20276	21295
Jacket / Color	PVC / Black	PVC / Black
Temperature range	-15 up to +80 °C	-20 up to +80 °C
Test voltage	300 V	300 V

PRE-ASSEMBLED – TYPE A

Part number	Cores	Type and Configuration	Dimensions in mm Outer-Ø	Length (m)	
● 50253671	8	USB® 3.2 Gen 1 x 1 (5 Gbit/s) Plug A – Plug A	5.50	1.80	
● 50261725	8	USB® 3.2 Gen 1 x 1 (5 Gbit/s) Plug A – Socket A	5.50	3.00	

PRE-ASSEMBLED – TYPE MICRO B

Part number	Cores	Type and Configuration	Dimensions in mm Outer-Ø	Length (m)	
● 50261727	8	USB® 3.2 Gen 1x1 (5 Gbit/s) Plug A – Micro-Plug B	5.50	3.00	

DATA CABLES USB® 3.2 GEN 2x2

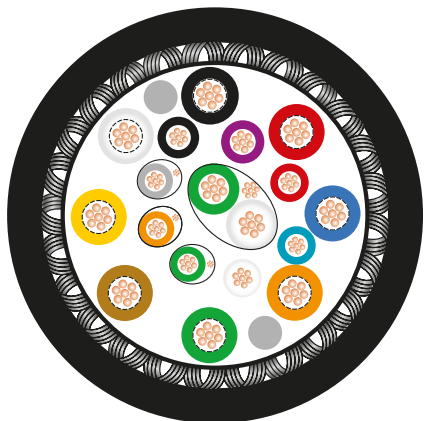

TECHNICAL DATA	PRE-ASSEMBLED – TYPE C PLUG (PASSIVE)	PRE-ASSEMBLED – TYPE C PLUG (ACTIVE)
Conductor	Stranded copper wire	Stranded copper wire
Composition	8 x AWG 30 / Coaxial 1 x 2 x AWG 30 2 x AWG 28 3 x AWG 30 3 x AWG 30 / Foil shield	8 x AWG 30 / Coaxial 1 x 2 x AWG 30 2 x AWG 28 3 x AWG 30 3 x AWG 30 / Foil shield
UL-Style	758	758
Jacket / Color	TPE / Black	PVC / Black
Temperature range	-20 up to +85 °C	-20 up to +85 °C
Temperature range at motion	±0 up to +50 °C	±0 up to +50 °C
Test voltage	300 V	300 V

PRE-ASSEMBLED – TYPE C PLUG (PASSIVE)

Part number	Cores	Type and Configuration	Dimensions in mm Outer-Ø	Length (m)	
● 50282854	18	USB® 3.2 Gen 2x2 (20 Gbit/s) Plug C – Plug C	4.90	2.00	

PRE-ASSEMBLED – TYPE C PLUG (ACTIVE)

Part number	Cores	Type and Configuration	Dimensions in mm Outer-Ø	Length (m)	
● 50282848	18	USB® 3.2 Gen 2x2 (40 Gbit/s) Plug C – Plug C	4.90	2.00	

DATA CABLES HDMI® 2.0

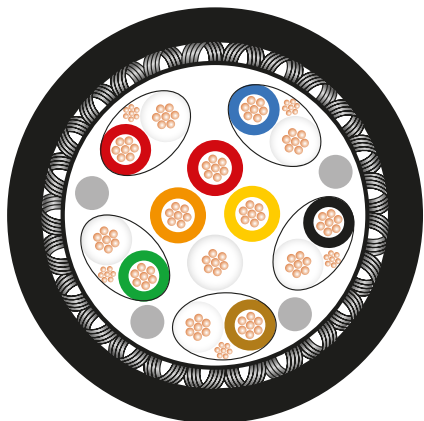

TECHNICAL DATA

Conductor	Stranded copper wire
Composition	5 x 2 x AWG 30 4 x AWG 30
UL-Style	20276
Jacket / Color	PVC / Black
Temperature range	-20 up to +80 °C
Test voltage	300 V/AC

PRE-ASSEMBLED

Part number	Cores	Type and Configuration	Dimensions in mm Outer-Ø	Approx. length (m)	
● 50283340	14	HDMI® 2.0 Cable Plug A – Socket A	7.30	0.50	
● 50283347	14	HDMI® 2.0 Cable Plug A – Socket A	7.30	1.00	
● 50283348	14	HDMI® 2.0 Cable Plug A – Socket A	7.30	3.00	

DATA CABLES HDMI® 2.1

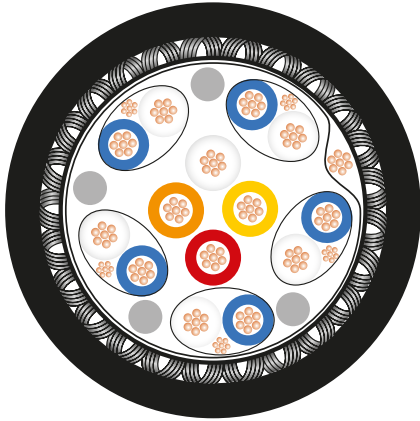

TECHNICAL DATA

Conductor	Stranded copper wire
Composition	Length 1 m / 2 m: 5 x 2 x AWG 30 4 x AWG 30
	Length 3 m: 5 x 2 x AWG 30 4 x AWG 28
UL-Style	20276
Jacket / Color	PVC / Black
Temperature range	-20 up to +80 °C
Test voltage	300 V/AC

PRE-ASSEMBLED

Part number	Cores	Type and Configuration	Dimensions in mm Outer-Ø	Approx. length (m)	
● 50304534	14	HDMI® 2.1 Cable Plug A – Plug A	6.30	1.00	
● 50304536	14	HDMI® 2.1 Cable Plug A – Plug A	6.30	2.00	
● 50304537	14	HDMI® 2.1 Cable Plug A – Plug A	7.30	3.00	

DATA CABLES DISPLAYPORT® 2.0

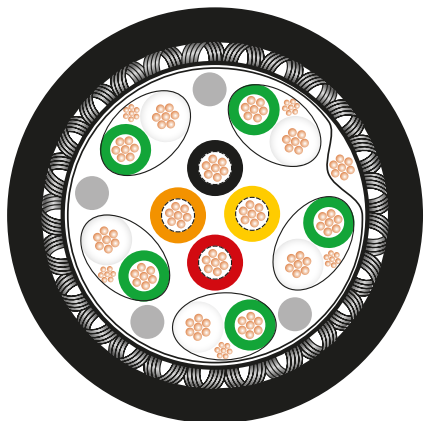

TECHNICAL DATA

Conductor	Stranded copper wire
Composition	5 x 2 x AWG 30 4 x AWG 30
UL-Style	20276
Jacket / Color	PVC / Black
Temperature range	-20 up to +80 °C
Test voltage	300 V/AC

PRE-ASSEMBLED

Part number	Cores	Type and Configuration	Dimensions in mm Outer-Ø	Approx. length (m)	
● 50304460	14	DP® 2.0 Cable Plug A – Plug A	6.20	1.00	
● 50304465	14	DP® 2.0 Cable Plug A – Plug A	6.80	3.00	
● 50304466	14	DP® 2.0 Cable Plug A – Plug A	7.00	5.00	

DATA CABLES SINGLE PAIR ETHERNET®

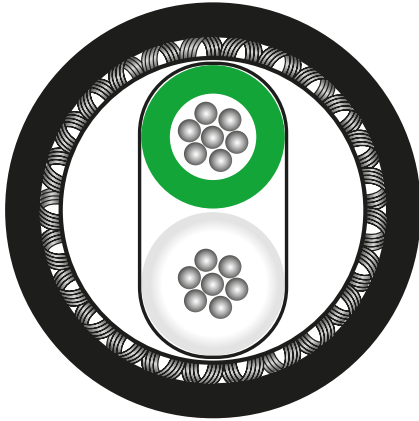

TECHNICAL DATA

	BY THE METER	PRE-ASSEMBLED
Conductor	Tinned copper wire	
Composition	1 x 2 x AWG 26	1 x 2 x AWG 22
Stranding	2 cores stranded to a pair	
Jacket / Color	PVC / Black ISO 19642-2, class B	PVC / Black
Insulation	PP Ø 1.26 mm	PE Ø 1.65 mm
Shielding	Tinned copper	
Temperature range	-40 up to +105 °C	-20 up to +80 °C

BY THE METER

Part number	Type	Cores	Dimensions in mm Outer-Ø
● 50299869	SPE Cable (10Gbit/s)	2	4.00

PRE-ASSEMBLED

Part number	Type	Cores	Dimensions in mm Outer-Ø	Approx. length (m)	
● 50531860	SPE Cable (1Gbit/s) Plug – Plug (IEC 63171-2)	2	5.10	5.00	
50531971	SPE Cable (1Gbit/s) Plug – Plug (IEC 63171-2)	2	5.10	15.00	

PATCH CABLES

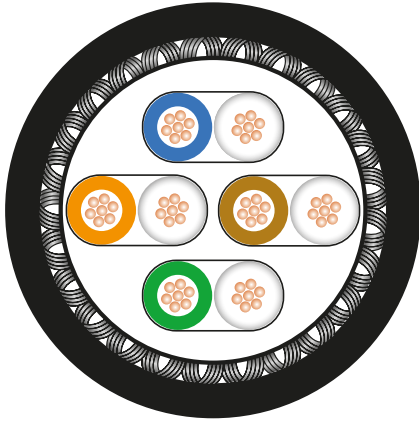

TECHNICAL DATA

	PUR	TPE-V
Conductor	Bare copper wire	
Stranding	2 cores stranded to a pair – 4 pairs	
Insulation	Foam-Skin PE, 1.05 mm	Foam-Skin PE, 1.05 mm
Jacket / Color	DMC FLEX PUR, Black	Halogen free TPE-V / Black
Shielding	Tinned copper braid	Copper braid
Pair shielding	Aluminium-coated plastic composite foil	
Operating temperature	-20 °C to +60 °C	-40 °C to +80 °C
Installation temperature	0 °C to +50 °C	-50 °C to +80 °C

BY THE METER (AWG 26)

Part number	Type	Cores	Jacket	Outer-Ø (mm)
● 50154386	Cat 7	8	PUR	6.40

Part number	Type	Cores	Jacket	Outer-Ø (mm)
● 50265542	Cat 7	8	TPE-V	6.50

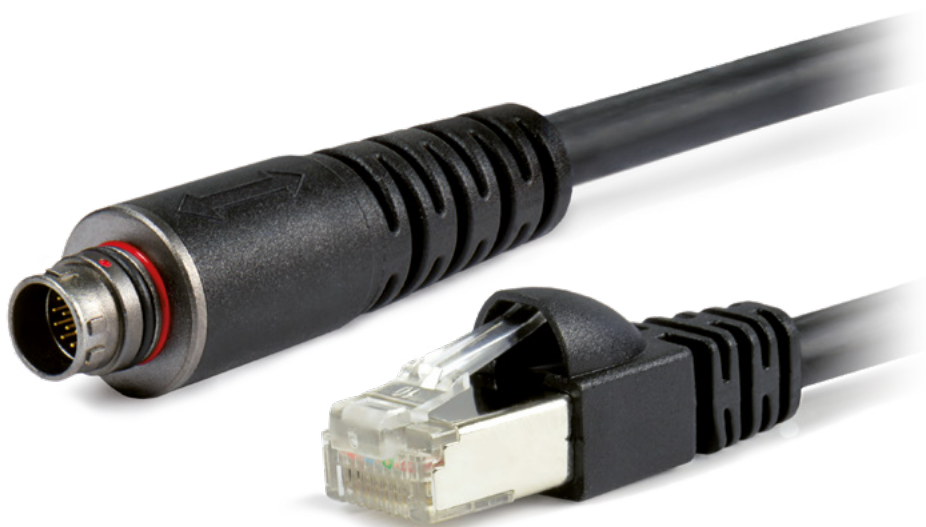

PATCH CABLES

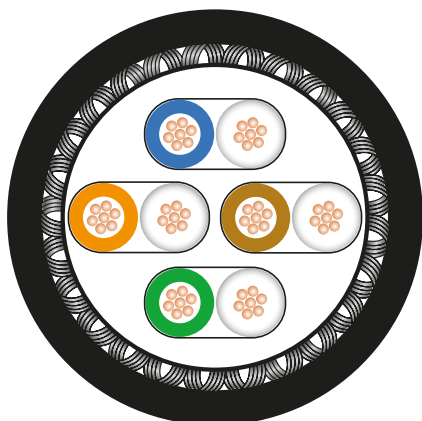

TECHNICAL DATA

Conductor	Bare copper wire, Ø 0.46 mm AWG 27 / 7
UL listed	E244889
Insulation	PE Ø 1.02 mm (core)
Jacket / Color	LSZH (jacket) / PVC (bend relief) / Black
Shielding	Tinned copper braid
Particle intrusion	IP2X
Water / submerge	IPX0
Ambient temperature	-40 °C to +75 °C
Halogen-free	IEC 60754-2
Flame retardant	IEC 60332-1; UL 444 CM
Transmission characteristics	Suitable for 10 Gigabit Ethernet Category 6A: ISO/IEC 11801; DIN EN 50173-1 Class EA: ISO/IEC 11801; DIN EN 50173-1 Category 6A: ANSI/TIA/EIA-568-C.2

PRE-ASSEMBLED – PIN / PIN

Part number	Type	Cores	Length in m	Outer-Ø (mm)	Color
● 50154589	Cat 6 _A	8	0.50	5.80 ± 0.20	Black
● 50278228	Cat 6 _A	8	1.00	5.80 ± 0.20	Black
● 50242421	Cat 6 _A	8	2.00	5.80 ± 0.20	Black
● 50154629	Cat 6 _A	8	5.00	5.80 ± 0.20	Black
● 50247616	Cat 6 _A	8	7.50	5.80 ± 0.20	Black
● 50241848	Cat 6 _A	8	10.00	5.80 ± 0.20	Black
● 50504100	Cat 6 _A	8	15.00	5.80 ± 0.20	Black
● 50504105	Cat 6 _A	8	20.00	5.80 ± 0.20	Black
● 50504106	Cat 6 _A	8	25.00	5.80 ± 0.20	Black
● 50504107	Cat 6 _A	8	50.00	5.80 ± 0.20	Black

Part number	Type	Cores	Length in m	Outer-Ø (mm)	Color
● 50240332	Cat 6 _A	8	3.00	5.80 ± 0.20	Gray
● 50237750	Cat 6 _A	8	5.00	5.80 ± 0.20	Yellow
● 50269400	Cat 6 _A	8	5.00	5.80 ± 0.20	Red
● 50266381	Cat 6 _A	8	25.00	5.80 ± 0.20	Red
● 50154362	Cat 6 _A	8	10.00	5.80 ± 0.20	Green

PRE-ASSEMBLED – PIN / SOCKET*

Part number	Type	Cores	Length in m	Outer-Ø (mm)	Color
● 50244069	Cat 6	8	3.00	6.20 ± 0.25	Black

*Technical information for pre-assembled pin/socket cables differs from pre-assembled pin/pin cables.



FIBER OPTIC CABLES

Glass optical fibers (Breakout cables)



TECHNICAL DATA

Fiber type	Multimode / singlemode
Fiber material	Quartz glass fiber
Primary coating	Acrylate
Operating temperature at rest	-25 up to +70 °C
Operating temperature in motion	-5 up to +50 °C

GLASS OPTICAL FIBERS (BREAKOUT CABLES)

Part number	Type	Mode	Fibers	AWG 14	AWG 18	AWG 22	AWG 26	Outer-Ø (mm)	Application area / jacket color
● 50506923	Fiber only	MM (OM4)	1	–	–	–	–	2.00	Indoor / Violet
● 50519407	Fiber only	SM (OS 2 G657)	1	–	–	–	–	2.00	Indoor / Yellow
● 50506925	Fiber only	MM (OM4)	1	–	–	–	–	3.90	Outdoor / Black
● 50519409	Fiber only	SM (OS 2 G657)	1	–	–	–	–	3.90	Outdoor / Black
50521383	Fiber only	MM (OM4)	2	–	–	–	–	5.90	Outdoor / Black
50521388	Fiber only	SM (OS 2 G657)	2	–	–	–	–	5.90	Outdoor / Black
● 50506926	Hybrid	MM (OM4)	2	2	–	2	–	9.90	Outdoor / Black
● 50519417	Hybrid	SM (OS 2 G657)	2	2	–	2	–	9.90	Outdoor / Black
50521389	Hybrid	MM (OM4)	2	–	–	–	16	8.80	Outdoor / Black
50521403	Hybrid	SM (OS 2 G657)	2	–	–	–	16	8.80	Outdoor / Black
50521404	Hybrid	MM (OM4)	1	–	–	2	–	6.00	Outdoor / Black
50521405	Hybrid	SM (OS 2 G657)	1	–	–	2	–	6.00	Outdoor / Black
50521406	Hybrid	MM (OM4)	1	–	2	2	–	7.40	Outdoor / Black
50521408	Hybrid	SM (OS 2 G657)	1	–	2	2	–	7.40	Outdoor / Black

FIBER OPTIC CABLES

Glass optical fibers (Loose tube cables)



TECHNICAL DATA

Fiber type	Multimode / singlemode
Fiber material	Quartz glass fiber
Primary coating	Acrylate
Jacket	Indoor: FRNC Outdoor: LSZH
Operating temperature	-40 up to +80 °C

GLASS OPTICAL FIBERS (LOOSE TUBE CABLES)

Part number	Type	Mode	Fibers	Outer-Ø (mm)	Application area / jacket color
● 50300996	Fiber only	MM (OM4)	12	6.00 ± 0.20	Outdoor / Black
● 50300997	Fiber only	SM (OS 2 G657)	12	6.00 ± 0.20	Outdoor / Black
● 50530709	Fiber only	MM (OM4)	12	3.00 ± 0.20	Indoor / Yellow
50530713	Fiber only	SM (OS 2 G657)	12	3.00 ± 0.20	Indoor / Yellow

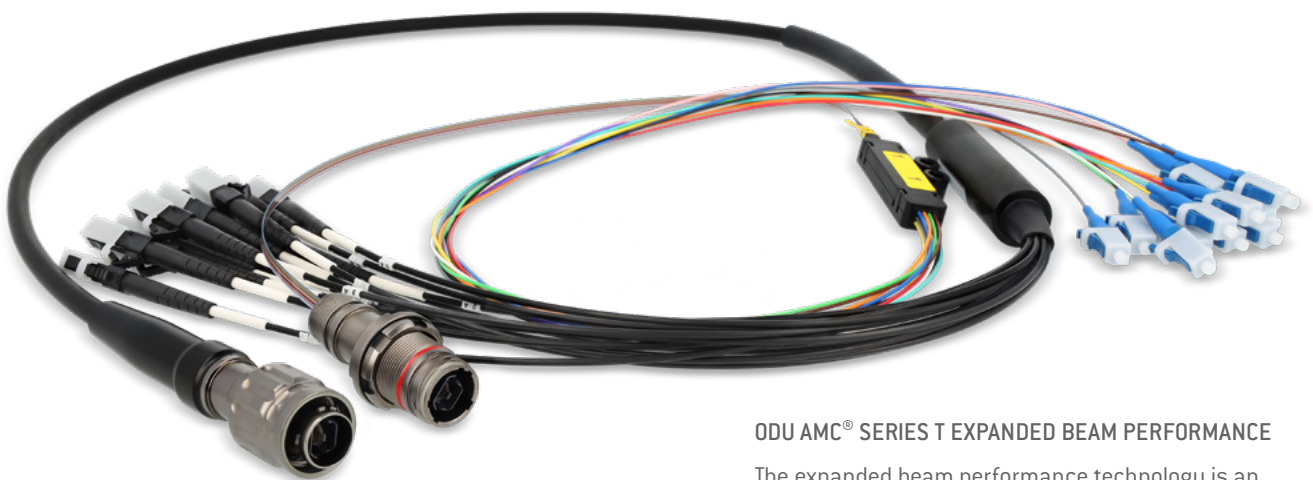

ODU AMC® SERIES T EXPANDED BEAM PERFORMANCE

The expanded beam performance technology is an enhanced fiber optic solution. It offers high-quality transmission characteristics and a high number of mating cycles. The optical performance is maintained even under mechanical stress, environmental influences, and harsh ambient conditions.

FIBER OPTIC CABLES

Glass optical fibers (Ribbon cables)

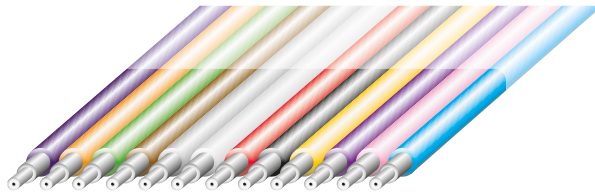

TECHNICAL DATA

Fiber type	Multimode / singlemode
Fiber material	Quartz glass fiber
Operating temperature	-40 up to +70 °C
Dimensions	Ca. 3.1 x 0.3 mm
Min. bending radius	25 mm (≤ 0.01 dB induced att.)
Standards	ICEA S-87-640 Telecordia GR-20-CORE IEC-60794-1-2
Application area	Suitable only for indoor use
Color of fibers	Blue, Orange, Green, Brown, Gray, White, Red, Black, Yellow, Violet, Pink, Turquoise

GLASS OPTICAL FIBERS (RIBBON CABLE)

Part number	Type	Mode	Fibers	Application area
● 50298373	Fiber only	MM (OM4)	12	Indoor
● 50298374	Fiber only	SM (OS 2 G657)	12	Indoor

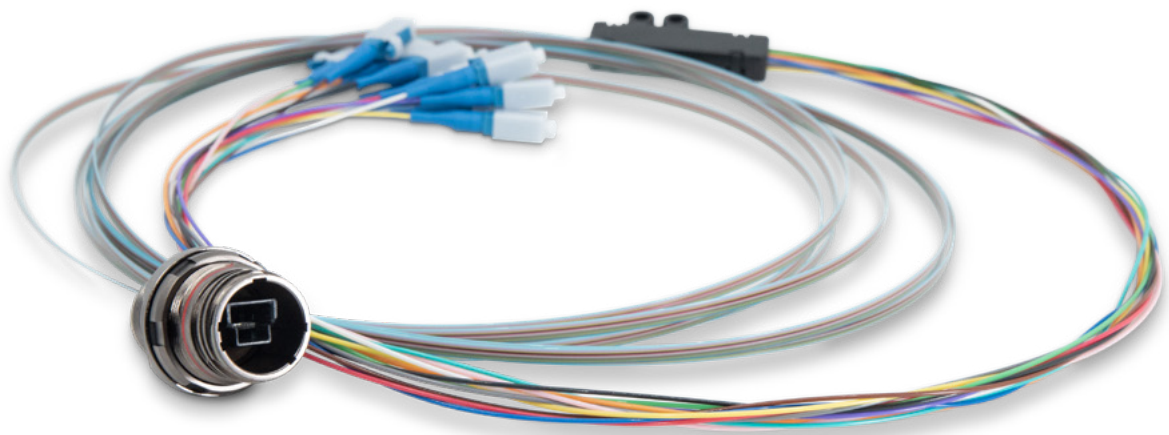

FIBER OPTIC CABLES

Polymer optical fibers (980 / 1,000 µm)



TECHNICAL DATA

Fiber type	Multimode
Fiber material	PMMA core and fluoropolymer cladding
Primary coating	PVC
Operating temperature	-40 up to +80 °C (up to +85 °C at max. 1,000 h operating time)

POLYMER OPTICAL FIBERS (980 / 1,000 µm)

Part number	Type	POF	AWG 14	AWG 16	AWG 18	AWG 22	AWG 26	Outer-Ø [mm]	Application area / jacket color
● 50295512	Fiber only	1	-	-	-	-	-	2.20	Indoor / Gray
● 50504407	Fiber only	1	-	-	-	-	-	3.90	Outdoor / Black
50525369	Fiber only	2	-	-	-	-	-	6.50	Outdoor / Black
50525371	Hybrid	1	-	-	-	2	-	6.20	Outdoor / Black
50525372	Hybrid	1	-	-	2	2	-	7.50	Outdoor / Black
● 50504409	Hybrid	2	2	-	-	2	-	9.70	Outdoor / Black
50525374	Hybrid	2	-	-	-	-	16	9.50	Outdoor / Black

CABLE LABELING

SELF-LAMINATING LABELS

Material: Permanent adhesive and flame retardant vinyl (B-427)

Operating temperature: -40 °C up to +70 °C

Color: Matte white / Transparent

Part number	Ø max [mm]	Dimensions [mm]		
		A	B	C printable area
● 50156161	3	12.70	19.05	9.53
● 50156162	4	19.05	23.81	9.52
● 50156163	7	20.32	36.50	12.70
● 50156164	10	19.05	44.45	12.70
● 50156165	12	25.40	57.15	19.05
● 50156166	19	48.26	80.95	19.05
● 50156167	36	25.40	152.40	38.10

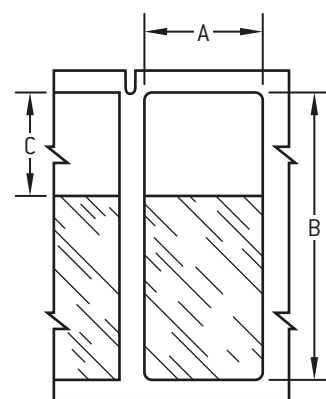
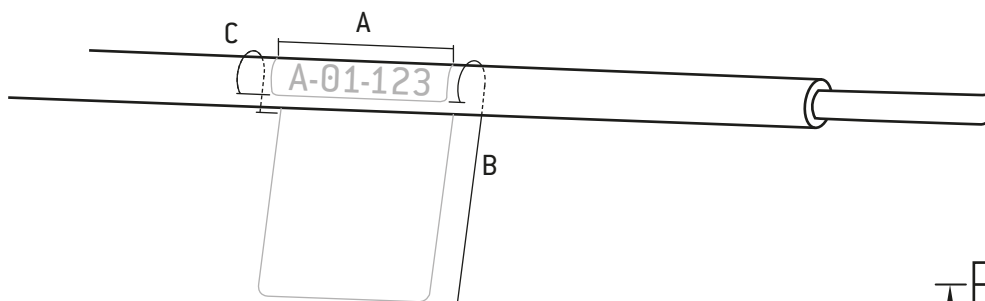

CABLE LABELING

HEAT SHRINKABLE TUBING

Material: Polyolefin
 Operating temperature: -55 °C up to +135 °C
 Max. storage temperature: +40 °C
 Imprint: Thermal-transfer
 Certifications: UL (File E35586); CSA (File 31929)
 Print color: Black / Silver

Part number	Color	Ø (mm) Cable	Ø (mm) before shrinking	Ø (mm) after shrinking
● 50157020	Black	0.80–1.90	2.36	0.79
● 50156880	White	0.80–1.90	2.36	0.79
● 50157021	Black	1.11–2.66	3.18	1.07
● 50156903	Yellow	1.11–2.66	3.18	1.07
● 50156881	White	1.11–2.66	3.18	1.07
● 50157022	Black	1.75–4.06	4.75	1.57
● 50156904	Yellow	1.75–4.06	4.75	1.57
● 50156882	White	1.75–4.06	4.75	1.57
● 50157023	Black	2.31–5.46	6.35	2.11
● 50156905	Yellow	2.31–5.46	6.35	2.11
● 50156883	White	2.31–5.46	6.35	2.11
● 50157019	Black	3.47–8.12	9.53	3.18
● 50156906	Yellow	3.47–8.12	9.53	3.18
● 50156884	White	3.47–8.12	9.53	3.18
● 50157025	Black	4.64–10.79	12.70	4.22
● 50156907	Yellow	4.64–10.79	12.70	4.22
● 50156885	White	4.64–10.79	12.70	4.22
● 50157026	Black	6.99–16.25	19.05	6.35
● 50156886	White	6.99–16.25	19.05	6.35



PCB CONNECTORS – MOLEX MICRO-FIT 3.0

WIRE-TO-WIRE / WIRE-TO-BOARD

Part number housing	Contacts	AWG	Contact type	Connection type	Series	Matching contacts
● 50278997	2	20–24	Socket	Crimp contact	Micro-Fit 3.0	50158769
		26–30				50279026
● 50158592	4	20–24	Socket	Crimp contact	Micro-Fit 3.0	50158769
		26–30				50279026
● 50279003	6	20–24	Socket	Crimp contact	Micro-Fit 3.0	50158769
		26–30				50279026
● 50268857	8	20–24	Socket	Crimp contact	Micro-Fit 3.0	50158769
		26–30				50279026
● 50241528	10	20–24	Socket	Crimp contact	Micro-Fit 3.0	50158769
		26–30				50279026
● 50158606	12	20–24	Socket	Crimp contact	Micro-Fit 3.0	50158769
		26–30				50279026
● 50279004	14	20–24	Socket	Crimp contact	Micro-Fit 3.0	50158769
		26–30				50279026
● 50279005	16	20–24	Socket	Crimp contact	Micro-Fit 3.0	50158769
		26–30				50279026
● 50158591	18	20–24	Socket	Crimp contact	Micro-Fit 3.0	50158769
		26–30				50279026
● 50158879	20	20–24	Socket	Crimp contact	Micro-Fit 3.0	50158769
		26–30				50279026
● 50279006	22	20–24	Socket	Crimp contact	Micro-Fit 3.0	50158769
		26–30				50279026
● 50279007	24	20–24	Socket	Crimp contact	Micro-Fit 3.0	50158769
		26–30				50279026

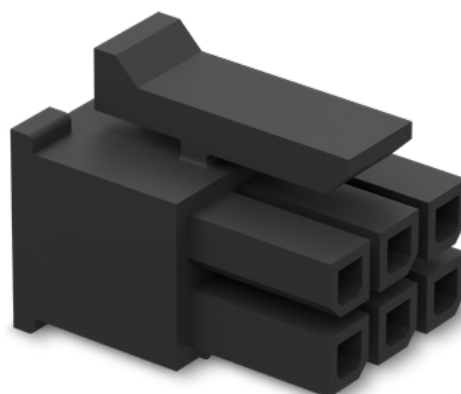

PCB CONNECTORS – MOLEX PICOBLADE 1.25 mm

WIRE-TO-WIRE / WIRE-TO-BOARD

Part number housing	Contacts	AWG	Contact type	Connection type	Series	Matching contacts
● 50158450	2	26–28	Socket	Crimp contact	Molex 1.25 mm	50158652
● 50158433	3	26–28	Socket	Crimp contact	Molex 1.25 mm	50158652
● 50248691	4	26–28	Socket	Crimp contact	Molex 1.25 mm	50158652
● 50158685	5	26–28	Socket	Crimp contact	Molex 1.25 mm	50158652
● 50158421	6	26–28	Socket	Crimp contact	Molex 1.25 mm	50158652
● 50158461	7	26–28	Socket	Crimp contact	Molex 1.25 mm	50158652
● 50158422	8	26–28	Socket	Crimp contact	Molex 1.25 mm	50158652
● 50251044	9	26–28	Socket	Crimp contact	Molex 1.25 mm	50158652
● 50158451	10	26–28	Socket	Crimp contact	Molex 1.25 mm	50158652
● 50263783	11	26–28	Socket	Crimp contact	Molex 1.25 mm	50158652
● 50279015	12	26–28	Socket	Crimp contact	Molex 1.25 mm	50158652
● 50279019	13	26–28	Socket	Crimp contact	Molex 1.25 mm	50158652
● 50158429	14	26–28	Socket	Crimp contact	Molex 1.25 mm	50158652
● 50279023	15	26–28	Socket	Crimp contact	Molex 1.25 mm	50158652

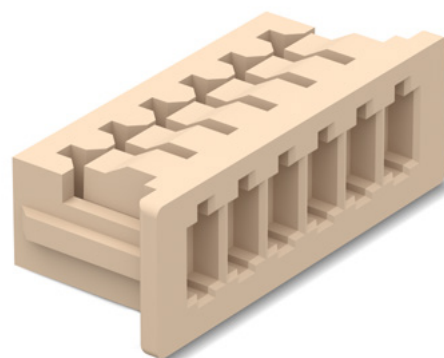

PCB CONNECTORS – JST PH

WIRE-TO-BOARD

Part number housing	Contacts	AWG	Contact type	Connection type	Series	Matching contacts
● 50267386	2	30–24	Socket	Crimp contact	PH	50158622
		28–24				50158624
● 50158822	3	30–24	Socket	Crimp contact	PH	50158622
		28–24				50158624
● 50158856	4	30–24	Socket	Crimp contact	PH	50158622
		28–24				50158624
● 50158823	5	30–24	Socket	Crimp contact	PH	50158622
		28–24				50158624
● 50158821	6	30–24	Socket	Crimp contact	PH	50158622
		28–24				50158624
● 50237802	7	30–24	Socket	Crimp contact	PH	50158622
		28–24				50158624
● 50158820	8	30–24	Socket	Crimp contact	PH	50158622
		28–24				50158624
● 50263548	9	30–24	Socket	Crimp contact	PH	50158622
		28–24				50158624
● 50158837	10	30–24	Socket	Crimp contact	PH	50158622
		28–24				50158624
● 50158828	11	30–24	Socket	Crimp contact	PH	50158622
		28–24				50158624
● 50279054	12	30–24	Socket	Crimp contact	PH	50158622
		28–24				50158624
● 50279055	13	30–24	Socket	Crimp contact	PH	50158622
		28–24				50158624
● 50279056	14	30–24	Socket	Crimp contact	PH	50158622
		28–24				50158624
● 50279057	15	30–24	Socket	Crimp contact	PH	50158622
		28–24				50158624
● 50279060	16	30–24	Socket	Crimp contact	PH	50158622
		28–24				50158624

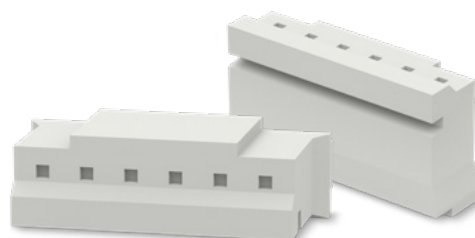

END TERMINALS

UNINSULATED

DIN (N): 46228

Material: SF-CU acc. to DIN 1787



Part number	AWG	mm ²	l	Dimensions (mm)		
				d1	d2	s
● 50153553	14	2.50	7.00	2.30	3.40	0.15
● 50153551	16	1.50	7.00	1.80	2.80	0.15
● 50153549	18	1.00	6.00	1.50	2.50	0.15
● 50153548	19	0.75	6.00	1.30	2.30	0.15
● 50153547	20	0.50	6.00	1.10	2.10	0.15
● 50153570	22	0.34	5.00	0.90	1.80	0.15
● 50153569	24	0.25	5.00	0.80	1.70	0.15
● 50153568	26	0.14	7.00	0.70	1.60	0.15
● 50153567	28	0.08	7.00	0.50	1.60	0.15

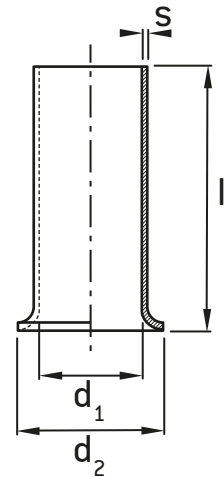

INSULATED

DIN (N): 46228

Material: SF-CU acc. to DIN 1787



Part number	AWG	Color	mm ²	Dimensions (mm)					
				l1	l2	d1	s1	d2	s2
● 50153583	14	Blue	2.50	14.00	8.00	2.20	0.15	4.20	0.25
● 50153581	16	Black	1.50	14.00	8.00	1.70	0.15	3.50	0.25
● 50153605	18	Red	1.00	14.00	8.00	1.40	0.15	3.00	0.25
● 50153603	19	Gray	0.75	14.00	8.00	1.20	0.15	2.80	0.25
● 50153600	20	White	0.50	14.00	8.00	1.00	0.15	2.60	0.25
● 50153599	22	Pink	0.34	10.40	6.00	0.90	0.15	2.00	0.25
● 50153596	24	Violet	0.25	10.40	6.00	0.80	0.15	1.80	0.25
● 50153592	26	Gray	0.14	10.40	6.00	0.70	0.12	1.10	0.25

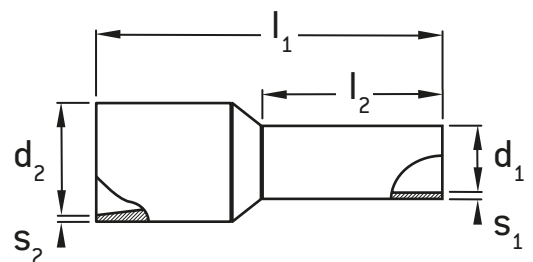

RING TERMINALS

UNINSULATED

Ring type: DIN 46234 and similar from 10 mm² acc. to VG 88710

Material: E-CU, surface galvanically tinned



Part number	AWG	Nominal Size	mm ²	Dimensions (mm)			
				d ₁	d ₂	l ₁	a ₁
● 50155951	26-20	M2	0.14-0.50	2.20	5.00	9.00	5
● 50155952		M3		3.20	5.00	9.00	5
● 50155953		M4		4.30	7.00	12.00	5
● 50280842		M5		5.30	8.00	12.00	5
● 50155954	20-16	M2.5	0.50-1.50	2.70	6.00	11.00	5
● 50155955		M3		3.20	6.00	11.00	5
● 50155956		M4		4.30	8.00	12.00	5
● 50280843		M5		5.30	10.00	13.00	5
● 50280844		M6		6.50	10.00	13.00	5
● 50280845		M8		8.50	14.00	17.00	5
● 50280846		M10		10.50	14.00	17.00	5
● 50155957	16-14	M3	1.500-2.500	3.20	6.00	11.00	5
● 50155958		M4		4.30	8.00	12.00	5
● 50155959		M5		5.30	10.00	14.00	5
● 50280847		M6		6.50	11.00	16.00	5
● 50280848		M8		8.40	14.00	17.00	5
● 50280849		M10		10.50	15.00	17.00	5
● 50280850		M12		13.00	18.00	20.00	5
● 50289082	12-10	M4	4.00-6.00	4.30	8.00	14.00	5
● 50289083		M5		5.30	10.00	15.00	5
● 50289084	8	M5	10.00	5.30	10.00	16.00	5

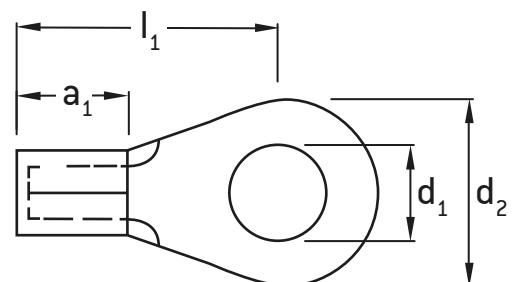

RING TERMINALS

INSULATED

Ring type: DIN 46237

Material: E-CU gal Sn / PA (insulation)



Part number	AWG	Color	Nominal Size	mm ²	Dimensions (mm)				
					d ₁	d ₂	d ₃	l ₁	a ₁
● 50155964	26–20	Yellow	M2	0.14–0.50	2.20	5.00	2.30	16.00	8.00
● 50155965			M3		3.20	5.00	2.30	16.00	8.00
● 50155966			M4		4.30	6.00	2.30	17.00	8.00
● 50281309			M5		5.30	8.00	2.30	16.00	8.00
● 50281310	20–16	Red	M2.5	0.50–1.50	2.70	6.00	4.00	16.00	10.00
● 50155967			M3		3.20	6.00	4.00	16.00	10.00
● 50155968			M4		4.30	8.00	4.00	17.00	10.00
● 50244675			M5		5.30	10.00	4.00	18.00	10.00
● 50281301			M6		6.50	11.00	4.00	21.00	10.00
● 50281302			M8		8.40	14.00	4.00	22.00	10.00
● 50281303			M10		10.50	18.00	4.00	22.00	10.00
● 50155969	16–14	Blue	M3	1.50–2.50	3.20	6.00	4.50	17.00	11.00
● 50155970			M4		4.30	8.00	4.50	18.00	11.00
● 50281305			M5		5.30	10.00	4.50	20.00	11.00
● 50243910			M6		6.50	11.00	4.50	22.00	11.00
● 50281306			M8		8.40	14.00	4.50	23.00	11.00
● 50281307			M10		10.50	18.00	4.50	25.00	11.00
● 50281308			M12		13.00	18.00	4.50	25.00	11.00
● 50289085	12–10	Yellow	M4	4.00–6.00	4.30	8.00	6.60	20.00	14.00
● 50155972			M5		5.30	10.00	6.60	21.00	14.00
● 50289087	10–8	Red	M5	6.00–10.00	5.30	10.00	7.50	24.00	16.00

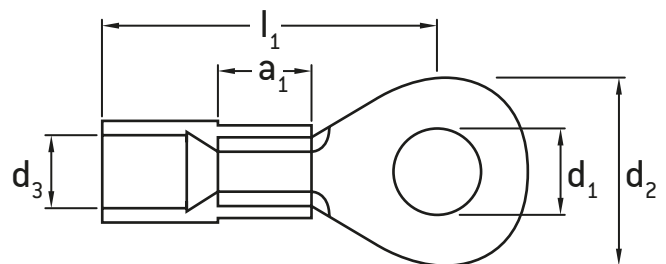

FLAT RECEPTACLE – STRAIGHT

UNINSULATED

Acc. to: DIN 46247 and DIN 46330

Material: E-CU gal Sn



Part number	AWG	mm ²	Dimensions (mm)	
			Plug-in width	Plug-in height
● 50281024	26–20	0.14–0.25	2.80	0.80
● 50281025	20–16	0.50–1.50	2.80	0.50
● 50281026			2.80	0.80
● 50281028			4.80	0.80
● 50158700			4.80	0.80
● 50158701			6.30	0.80
● 50281029	16–14	1.50–2.50	4.80	0.80
● 50158717			6.30	0.80

INSULATED

Acc. to: DIN 46247 and DIN 46330

Material: E-CU gal Sn / PA (insulation)



Part number	AWG	Color	mm ²	Dimensions (mm)	
				Plug-in width	Plug-in height
● 50281136	26–20	Yellow	0.14–0.50	2.80	0.50
● 50281137				2.80	0.80
● 50281138	20–16	Red	0.50–1.50	2.80	0.50
● 50281139				2.80	0.80
● 50281140				4.80	0.50
● 50241589				4.80	0.80
● 50263182				6.30	0.80
● 50281141	16–14	Blue	1.50–2.50	2.80	0.50
● 50281142				2.80	0.80
● 50281144				4.80	0.50
● 50281147				4.80	0.80
● 50158752				6.30	0.80

CORRUGATED TUBE GLANDS

TUBE GLANDS (FOR CORRUGATED TUBES)

Material: Nickel-plated brass and plastic (polyamide 6)

[The glands match the corrugated tubes on page 84.](#)

Part number	Thread	Clamping range (mm)	Suitable sealing insert	Color
● 50290381	M25 x 1.50	9.00–13.00	N/A	Black
● 50262674	M25 x 1.50	customizable ¹	50253520	Black
● 50290382	M32 x 1.50	17.00–20.50	N/A	Black
● 50262696	M32 x 1.50	customizable ¹	50253543	Black
● 50290383	M40 x 1.50	24.00–28.00	N/A	Black
● 50244674	M40 x 1.50	customizable ¹	50253549	Black
● 50290384	M50 x 1.50	32.00–36.00	N/A	Black
● 50262722	M50 x 1.50	customizable ¹	50253556	Black

¹ The sealing insert can be drilled if multiple cables are fed through the gland.

TUBE GLANDS (FOR CORRUGATED HOSES)

Material: Plastic (polyamide 6)

[The glands match the corrugated hoses on page 84.](#)

Part number	Thread	Clamping range (mm)	Color
● 50262465	M25 x 1.50	11.00–16.00	Gray
● 50245149	M32 x 1.50	15.00–21.00	Gray
● 50245097	M40 x 1.50	16.00–26.00	Gray
● 50262522	M50 x 1.50	27.00–35.00	Gray



TUBES AND HOSES

CORRUGATED TUBES

Material: Plastic (polyamide 6)

[The corrugated tubes match the glands on page 83.](#)

Part number	Thread	Nominal size
● 50262751	M25 x 1.50	23
● 50262754	M32 x 1.50	29
● 50241062	M40 x 1.50	36
● 50262760	M50 x 1.50	48

CORRUGATED HOSES

Material: Polyurethane

[The corrugated hoses match the glands on page 83.](#)

Part number	Thread	Nominal size
● 50262587	M25 x 1.50	21
● 50245168	M32 x 1.50	28
● 50156804	M40 x 1.50	34
● 50262593	M50 x 1.50	42

BRAIDED SLEEVING

Material: Polyamide PA6.6 – halogen-free

Part number	Clamping range (mm)	Nominal size
● 50262763	4.00–10.00	6
● 50262764	10.00–14.00	12
● 50262769	14.00–24.00	16

Part number	Clamping range (mm)	Nominal size
● 50262770	18.00–26.00	20
● 50160254	26.00–34.00	30
● 50262772	32.00–42.00	40



CABLE GLANDS

CABLE GLANDS

Material: Plastic (polyamide)

Color: White, Gray, Black

Part number	Thread M	SW	Dimensions (mm)			Color
			Clamping range D	Total length C	Thread length A	
● 50231135	M25 x 1.50	30.00	9.00–17.00	40.00	10.00	White
● 50231136						Gray
● 50020194						Black
● 50231138	M32 x 1.50	36.00	11.00–21.00	47.00	10.00	White
● 50231139						Gray
● 50020196						Black
● 50231140	M40 x 1.50	46.00	19.00–28.00	52.00	10.00	White
● 50231141						Gray
● 50238956						Black
● 50231142	M50 x 1.50	55.00	27.00–35.00	62.00	12.00	White
● 50231143						Gray

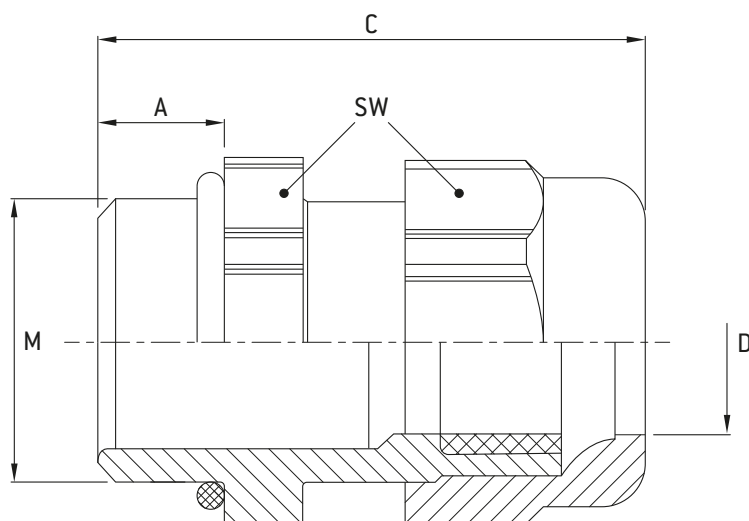

CABLE GLANDS WITH SEALING INSERTS

CABLE GLANDS

Material cable gland: Plastic (polyamide), Black

Material sealing insert: TPE (Thermoplastic elastomers)

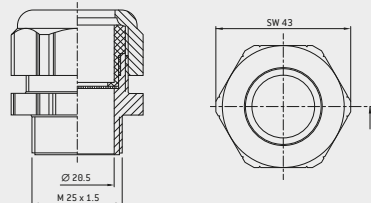
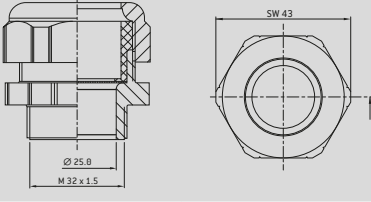
Part number	Thread	Clamping range	Inner diameter Ø in mm	Technical drawing	Sealing insert part number
● 50254736	M25 x 1.50	17.00–20.50	20.50		50253520
● 50253364	M25 x 1.50	24.00–28.00	20.50		50253543
● 50290386	M25 x 1.50	14.00–18.00	21.00		50253520
● 50290392	M32 x 1.50	20.00–25.00	25.00		50253543
● 50253380	M32 x 1.50	24.00–28.00	25.00		50253543

CABLE GLANDS WITH SEALING INSERTS

CABLE GLANDS

Material cable gland: Plastic (polyamide), Black

Material sealing insert: TPE (Thermoplastic elastomers)

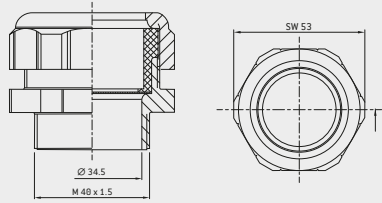
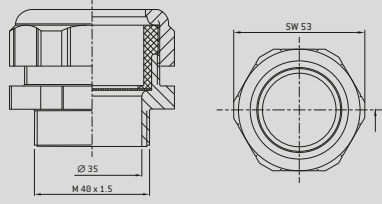
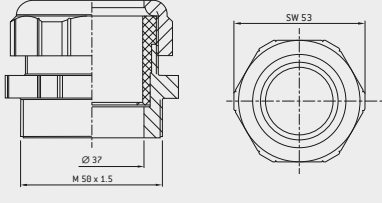
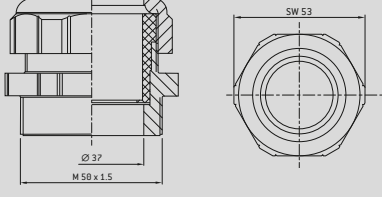
Part number	Thread	Clamping range	Inner diameter Ø in mm	Technical drawing	Sealing insert part number
● 50253465	M40 x 1.50	32.00–36.00	34.50		50253549
● 50290393	M40 x 1.50	27.00–32.00	35.00		50253549
● 50290394	M50 x 1.50	37.00–32.00	37.00		50233561
● 50253479	M50 x 1.50	32.00–36.00	37.00		50253561



CABLE GLANDS WITH SEALING INSERTS

CABLE GLANDS

Material cable gland: Nickel plated brass

Material sealing insert: TPE (Thermoplastic elastomers)

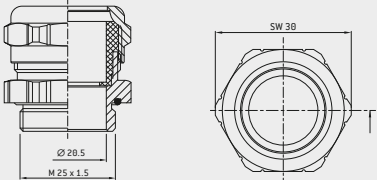
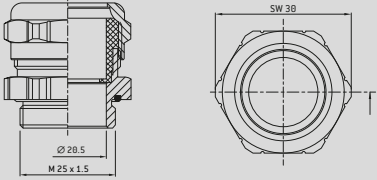
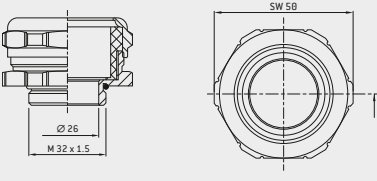
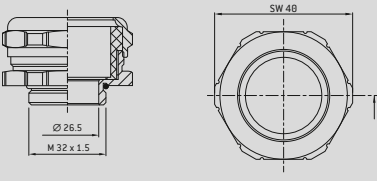
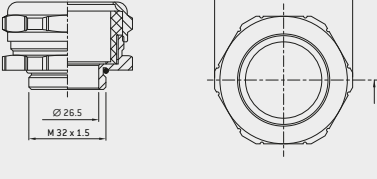
Part number	Thread	Clamping range	Inner diameter Ø in mm	Technical drawing	Sealing insert part number
● 50253340	M25 x 1.50	17.00–20.50	20.50		50253520
● 50290395	M25 x 1.50	14.00–18.00	20.50		50253520
● 50253376	M32 x 1.50	32.00–36.00	26.00		50253549
● 50254723	M32 x 1.50	24.00–28.00	26.50		50253543
● 50290396	M32 x 1.50	20.00–25.00	26.50		50253543

CABLE GLANDS WITH SEALING INSERTS

CABLE GLANDS

Material cable gland: Nickel plated brass

Material sealing insert: TPE (Thermoplastic elastomers)

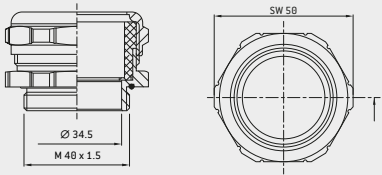
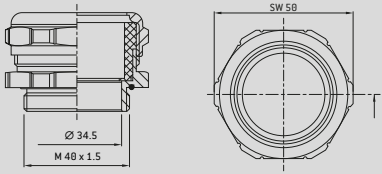
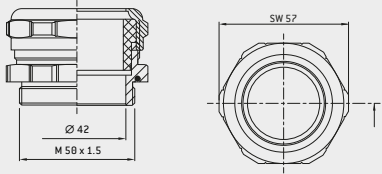
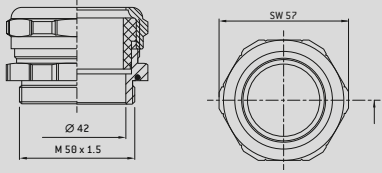
Part number	Thread	Clamping range	Inner diameter Ø in mm	Technical drawing	Sealing insert part number
● 50253447	M40 x 1.50	32.00–36.00	34.50		50253549
● 50290397	M40 x 1.50	27.00–32.00	34.50		50253549
● 50290398	M50 x 1.50	33.00–38.00	42.00		50253556
● 50253473	M50 x 1.50	36.00–40.00	42.00		50253556



CUSTOMIZABLE SEALING INSERTS

ONLY SUITABLE FOR THE STANDARD CABLE GLANDS FROM LAPP

Material: Chloroprene rubber (CR)

Color: Black

Part number	Ø D (mm)	L (mm)	Thread
● 50253751	17.20	9.50	M25
● 50253756	21.20	12.00	M32
● 50253764	28.20	14.50	M40
● 50253767	35.80	18.00	M50

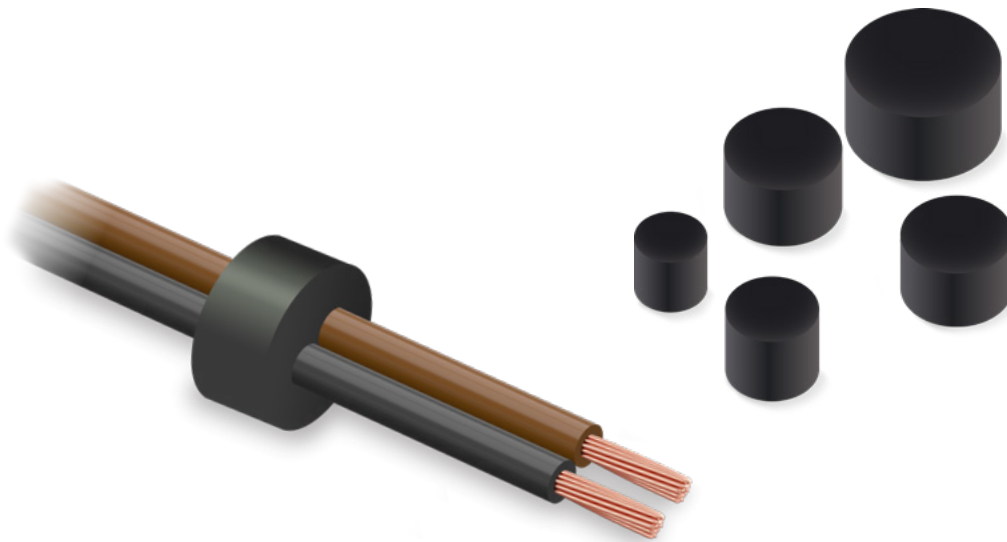
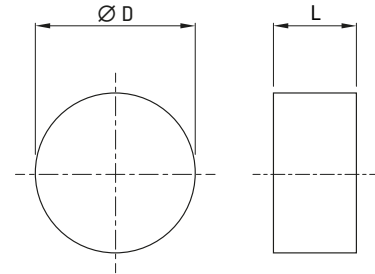

AIR- AND FLUID HOSES

LUBRICANTS

Material: Polyamide

Color: Blue

Part number	Usage	Dimensions (mm)	
		Outer-Ø	Inner-Ø
● 50279622	Lubricants	6.00	2.50
● 50279623		8.00	4.00
● 50279625		10.00	6.00
● 50279626		12.00	7.50
● 50279629		14.00	9.00

COMPRESSED AIR & WATER

Material: Polyurethane

Color: Black

Part number	Usage	Dimensions (mm)	
		Outer-Ø	Inner-Ø
● 50279630	Compressed air & water	3.00	2.10
● 50279632		4.00	2.60
● 50279633		6.00	4.00
● 50279634		8.00	5.70
● 50279635		10.00	7.00
● 50279636		12.00	8.00

CONDUCTOR RESISTANCES

ACC. TO IEC / EN 60228; HD 383; VDE 0295

Nominal cross section mm ²	Bare copper conductor (Ω / km)		Cu-conductor tin-plated (Ω / km)	
	Class 1 & 2	Class 5 & 6	Class 1 & 2	Plug-in height
0.05	–	~ 380	–	~ 392
0.08	–	~ 237	–	~ 244
0.11	–	~ 170	–	~ 175
0.126	–	~ 150	–	~ 155
0.14	–	~ 134	–	~ 138
0.22	–	~ 96	–	~ 99
0.25	–	~ 76	–	~ 79
0.34	–	~ 53	–	~ 56
0.50	36.00	39.00	36.70	40.10
0.75	24.50	26.00	24.80	26.70
1.00	18.10	19.50	18.20	20.00
1.50	12.10	13.30	12.20	13.70
2.50	7.41	7.98	7.56	8.21
4.00	4.61	4.95	4.70	5.09
6.00	3.08	3.30	3.11	3.39
10.00	1.83	1.91	1.84	1.95

The values are listed according to DIN VDE 0295 (corresponds to the international standards EN 60228 and HD 383), depending on the conductor cross-section and conductor class, but from 0.5 mm². The cross sections of the individual wires of each stranded conductor must not exceed the specified maximum values (see DIN VDE 0295), which are necessary to maintain the maximum conductor resistance at 20 °C.

- Class 1** = Solid conductors for single and multi-core cables
- Class 2** = Stranded conductors for single and multicore cables
- Class 5** = Fine-stranded copper conductors for single and multi-core cables
- Class 6** = Fine-stranded copper conductors for single and multi-core cables

WIRE CONSTRUCTIONS

ACC. TO IEC / EN 60228; HD 383; VDE 0295

Conductor cross section mm ²	Stranded Class 2 DIN VDE 0295	Multiple-wire	Flexible Class 5 DIN VDE 0295	Highly flexible Class 6 DIN VDE 0295			
	Wire count x Single wire Ø	Wire count x Single wire Ø	Wire count x Single wire Ø	Wire count x Single wire Ø	Wire count x Single wire Ø	Wire count x Single wire Ø	Wire count x Single wire Ø
0.14	–	7 x 0.16	~ 18 x 0.10	~ 18 x 0.10	~ 18 x 0.10	~ 36 x 0.07	~ 72 x 0.05
0.25	–	–	~ 14 x 0.15	~ 32 x 0.10	~ 32 x 0.10	~ 65 x 0.07	~ 128 x 0.05
0.34	–	7 x 0.25	~ 19 x 0.15	~ 42 x 0.10	~ 42 x 0.10	~ 88 x 0.07	~ 180 x 0.05
0.38	–	7 x 0.27	~ 12 x 0.20	~ 21 x 0.15	~ 48 x 0.10	~ 100 x 0.07	~ 194 x 0.05
0.50	7 x 0.30	7 x 0.30	~ 16 x 0.20	~ 28 x 0.15	~ 64 x 0.10	~ 131 x 0.07	~ 256 x 0.05
0.75	7 x 0.37	7 x 0.37	~ 24 x 0.20	~ 42 x 0.15	~ 96 x 0.10	~ 195 x 0.07	~ 384 x 0.05
1.00	7 x 0.43	7 x 0.43	~ 32 x 0.20	~ 56 x 0.15	~ 128 x 0.10	~ 260 x 0.07	~ 512 x 0.05
1.50	7 x 0.52	7 x 0.52	~ 30 x 0.25	~ 84 x 0.15	~ 192 x 0.10	~ 392 x 0.07	~ 768 x 0.05
2.50	7 x 0.67	~ 19 x 0.41	~ 50 x 0.25	~ 140 x 0.15	~ 320 x 0.10	~ 651 x 0.07	~ 1280 x 0.05
4.00	7 x 0.85	~ 19 x 0.52	~ 56 x 0.30	~ 224 x 0.15	~ 512 x 0.10	~ 1040 x 0.07	–
6.00	7 x 1.05	~ 19 x 0.64	~ 84 x 0.30	~ 192 x 0.20	~ 768 x 0.10	~ 1560 x 0.07	–
10.00	7 x 1.35	~ 49 x 0.51	~ 80 x 0.40	~ 320 x 0.20	~ 1280 x 0.10	~ 2600 x 0.07	–
16.00	7 x 1.70	~ 49 x 0.65	~ 128 x 0.40	~ 512 x 0.20	~ 2048 x 0.10	–	–
25.00	7 x 2.13	~ 84 x 0.62	~ 200 x 0.40	~ 800 x 0.20	~ 3200 x 0.10	–	–
35.00	7 x 2.52	~ 133 x 0.58	~ 280 x 0.40	~ 1120 x 0.20	–	–	–
50.00	~ 19 x 1.83	~ 133 x 0.69	~ 400 x 0.40	~ 705 x 0.30	–	–	–
70.00	~ 19 x 2.17	~ 189 x 0.69	~ 356 x 0.50	~ 990 x 0.30	–	–	–
95.00	~ 19 x 2.52	~ 259 x 0.69	~ 485 x 0.50	~ 1340 x 0.30	–	–	–
120.00	~ 37 x 2.03	~ 336 x 0.67	~ 614 x 0.50	~ 1690 x 0.30	–	–	–

AWG WIRE TABLE

AWG	Diameter cross section				R (Ω /km)	Metric equivalent (mm ²)	SWG	BWG (Stubs)	W&M
	Inch	mm	kcmil	mm ²					
0000 (4/0)	0.460	11.68	212	107.2	0.166	120	–	–	–
000 (3/0)	0.410	10.40	168	85.01	0.209	95	–	–	–
00 (2/0)	0.365	9.266	133	67.43	0.264	70	–	–	–
0 (1/0)	0.325	8.25	106	53.49	0.333	–	–	–	–
1	0.289	7.35	83.7	42.40	0.42	50	–	–	–
2	0.258	6.54	66.4	33.62	0.529	35	–	–	–
3	0.229	5.83	52.6	26.67	0.667	–	–	–	–
4	0.204	5.19	41.7	21.15	0.842	25	–	–	–
5	0.182	4.62	33.1	16.75	1.06	–	–	–	–
6	0.162	4.11	26.2	13.30	1.34	16	–	–	8
7	0.144	3.67	20.8	10.55	1.69	–	9	–	–
8	0.128	3.26	16.5	8.37	2.13	10	10	–	–
9	0.114	2.91	–	6.63	2.68	–	–	–	–
10	0.102	2.59	10.4	5.26	3.38	6	–	–	–
11	0.0907	2.30	–	4.17	4.27	–	–	–	–
12	0.0808	2.05	6.53	3.31	5.38	4	14	–	14
13	0.0720	1.83	–	2.62	6.78	–	15	15	15
14	0.0641	1.63	4.11	2.08	8.550	2.5	16	–	–
15	0.0571	1.45	–	1.65	10.80	–	–	–	–
16	0.0508	1.29	2.58	1.31	13.60	1.5	–	–	–
17	0.0453	1.15	–	1.038	17.10	–	–	–	–
18	0.0403	1.024	1.62	0.823	21.60	1	19	–	–
19	0.0359	0.912	–	0.653	27.30	0.75	20	–	–
20	0.0320	0.812	1.02	0.518	34.40	0.75	–	–	21
21	0.0285	0.723	–	0.410	43.40	0.5	22	22	22
22	0.0254	0.644	0.64	0.326	54.70	0.34	–	23	–
23	0.0226	0.573	–	0.258	68.90	–	–	–	–
24	0.0201	0.511	0.404	0.205	86.90	0.25	25	25	25
25	0.0179	0.455	–	0.162	110.00	–	26	26	26
26	0.0159	0.405	–	0.129	138.00	0.14	–	27	–
27	0.0142	0.361	–	0.102	174.00	–	–	28	–
28	0.0126	0.321	–	0.0810	220.00	0.09	–	–	–

COLOR CODE ACC. TO DIN 47100

CORED WITHOUT COLOR REPETITION

Core	Core Color	Code
1	White	ws
2	Brown	br
3	Green	gn
4	Yellow	ge
5	Gray	gr
6	Pink	rs
7	Blue	bl
8	Red	rt
9	Black	sw
10	Violet	vio
11	Gray-Pink	grrs
12	Red-Blue	rtbl
13	White-Green	wsgn
14	Brown-Green	brgn
15	White-Yellow	wsge
16	Yellow-Brown	gebr
17	White-Gray	wsgr
18	Gray-Brown	grbr
19	White-Pink	wsrs
20	Pink-Brown	rsbr
21	White-Blue	wsbl
22	Brown-Blue	brbl
23	White-Red	wsrt
24	Brown-Red	brrt
25	White-Black	wssw
26	Brown-Black	brsw
27	Gray-Green	grgn
28	Yellow-Gray	gegr
29	Pink-Green	rsgn
30	Yellow-Pink	gers
31	Green-Blue	gnbl

Core	Core Color	Code
32	Yellow-Blue	gebl
33	Green-Red	gnrt
34	Yellow-Red	gert
35	Green-Black	gns
36	Yellow-Black	ges
37	Gray-Blue	grbl
38	Pink-Blue	gsbl
39	Gray-Red	grrt
40	Pink-Red	rsrt
41	Gray-Black	grsw
42	Pink-Black	rss
43	Blue-Black	blsw
44	Red-Black	rtsw
45	White-Brown-Black	wsbrsw
46	Yellow-Green-Black	gegns
47	Gray-Pink-Black	grrss
48	Blue-Red-Black	blrtsw
49	White-Green-Black	wsgnsw
50	Green-Brown-Black	gnbrsw
51	White-Yellow-Black	wsges
52	Yellow-Brown-Black	gebrsw
53	White-Gray-Black	wsgrsw
54	Gray-Brown-Black	grbrsw
55	White-Pink-Black	wsrsw
56	Pink-Brown-Black	rsbrsw
57	White-Blue-Black	wsblsw
58	Brown-Blue-Black	brblsw
59	White-Red-Black	wsrtsw
60	Brown-Red-Black	brrtsw
61	Black-White	swws

- The cores are counted starting in the outer layer and continuing through all layers in the same direction. The first color is the base color
- The 2nd and 3rd color is applied in the form of abrasion-resistant color rings. For 2 and 3-colored cores, the characters of the color code are lined up directly next to each other
- For cables with color repetition, the color code starts again with White (1) from the 45th core onwards.
- For paired cores, always the two colors named in sequence are stranded. The color code is repeated from the 23rd and 45th pair onwards.

INTERNATIONAL COLOR CODE / IC - CODE

FOR UL / CSA CONTROL CABLES

Core	Core Color
1	Black
2	Brown
3	Red
4	Orange
5	Yellow
6	Green
7	Blue
8	Violet
9	Gray
10	White
11	White-Black
12	White-Brown
13	White-Red
14	White-Orange
15	White-Yellow
16	White-Green
17	White-Blue
18	White-Violet
19	White-Gray
20	Brown-Black
21	Brown-Red
22	Brown-Orange
23	Brown-Yellow
24	Brown-Green
25	Brown-Blue
26	Brown-Violet
27	Brown-Gray
28	Brown-White
29	Green-Black
30	Green-Brown

Core	Core Color
31	Green-Red
32	Green-Orange
33	Green-Blue
34	Green-Violet
35	Green-Gray
36	Green-White
37	Yellow-Black
38	Yellow-Brown
39	Yellow-Red
40	Yellow-Orange
41	Yellow-Blue
42	Yellow-Violet
43	Yellow-Gray
44	Yellow-White
45	Gray-Black
46	Gray-Brown
47	Gray-Red
48	Gray-Orange
49	Gray-Yellow
50	Gray-Green
51	Gray-Blue
52	Gray-Violet
53	Gray-White
54	Orange-Black
55	Orange-Brown
56	Orange-Red
57	Orange-Yellow
58	Orange-Green
59	Orange-Blue
60	Orange-Violet



Printed on certified
recycled paper.

All dimensions are in mm.
Some figures are for illustrative purposes only. Subject to change
without notice. Errors and omissions excepted. We reserve the right to
change our products and their technical specifications at any time in
the interest of technical improvement. This publication supersedes all
prior publications.

STANDARD CABLES AND ACCESSORIES / C / 0823 / EN

This publication is also available as a PDF file that can be downloaded
from www.odu-connectors.com